



Piezoelectric Actuators

COMPONENTS, TECHNOLOGIES, OPERATION

Contents

PI Ceramic – Leaders in Piezo Technology	3
---	---

Piezo Actuators

P-882 – P-888 PICMA® Stack Multilayer Piezo Actuators	6
Custom Designs	8
P-885 • P-888 Encapsulated PICMA® Stack Piezo Actuators	9
P-088 Round PICMA® Stack Multilayer Piezo Actuator	10
P-080 PICMA® Stack Multilayer Ring Actuator	12
PD0xx Round PICMA® Chip Actuators	14
PL0xx PICMA® Chip Actuators	15
PL112 – PL140 • PD410 PICMA® Bender Piezo Actuators	16
P-876 DuraAct Patch Transducer	18
P-878 DuraAct Power Patch Transducer	20
PT120 – PT140 Piezo Tube Actuators	22
P-007 – P-056 PICA Stack Piezo Actuators	24
P-010.xxP – P-056.xxP PICA Power Piezo Actuators	26
P-00.xxH – P-025.xxH PICA Thru Ring Actuators	28
P-111 – P-151 PICA Shear Actuators	30
P-405 Picoactuator®	32
Integrated Components	33

Amplifiers / Drivers for Piezo Actuators	34
---	----

Piezo Technology

Table of Contents	38
Basic Principles of Piezoelectricity	39
Properties of Piezoelectric Actuators	49
Amplifier Technology: Piezo Electronics for Operating Piezo Actuators	65
Handling of Piezo Actuators	68

PI (Physik Instrumente)

The PI Group Milestones	70
Product Portfolio	72

Imprint

PI Ceramic GmbH, Lindenstrasse, 07589 Lederhose, Germany
Registration: HRB 203.582, Jena local court
VAT no.: DE 155932487
Executive board: Albrecht Otto, Dr. Peter Schittenhelm, Dr. Karl Spanner
Phone +49 36604 / 882-0, Fax +49-36604 882-4109
info@piceramic.com, www.piceramic.com

Although the information in this document has been compiled with the greatest care, errors cannot be ruled out completely. Therefore, we cannot guarantee for the information being complete, correct and up to date. Illustrations may differ from the original and are not binding. PI reserves the right to supplement or change the information provided without prior notice.

© Physik Instrumente (PI) GmbH & Co. KG

All contents, including texts, graphics, data etc., as well as their layout, are subject to copyright and other protective laws. Any copying, modification or redistribution in whole or in parts is subject to a written permission of PI.

The following company names and brands are registered trademarks of Physik Instrumente (PI) GmbH & Co. KG :

PI®, PIC®, NanoCube®, PICMA®, PIFOC®, PILine®, NEXLINE®, PiezoWalk®, PicoCube®, PiezoMove®, PIMikroMove®, NEXACT®, Picoactuator®, Plnano®, NEXSHIFT®, PITouch®, PIMag®, PIHera®, Q-Motion®

The following company names or brands are the registered trademarks of their owners:

µManager, LabVIEW, Leica, Linux, MATLAB, MetaMorph, Microsoft, National Instruments, Nikon, Olympus, Windows, Zeiss

PI Ceramic

LEADERS IN PIEZO TECHNOLOGY

PI Ceramic is one of the world's market leaders for piezoelectric actuators and sensors. PI Ceramic provides everything from piezoceramic components to system solutions for research and industry in all high-tech markets including medical engineering, mechanical engineering and automobile manufacture, or semiconductor technology.

PI Ceramic is a subsidiary of Physik Instrumente (PI) and develops and produces all piezo actuators for PI's nan positioning systems. The drives for PILINE® ultrasonic piezomotors and NEXLINE® high-load stepping drives also originate from PI Ceramic.

Custom Designs

The very nature of PI Ceramic makes it possible to react to customer wishes in the shortest possible time.

PI Ceramic has specialized in quantities of a few 100 to several 100,000. Our development and consulting engineers have an enormous wealth of experience concerning the application of piezo actuators and sensors and already work very closely with the developers of our customers in the run-up to a project. This allows you to put successful products on the market faster.

Materials Research and Development

PI Ceramic develops all its piezoceramic materials itself. To this end PI Ceramic main-

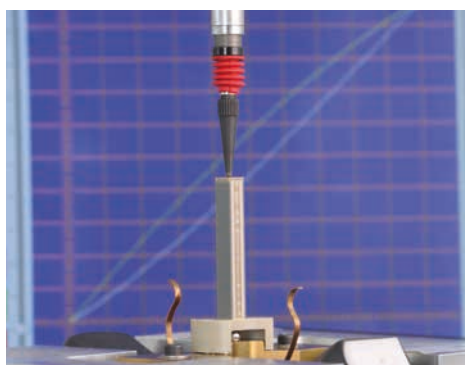

tains its own laboratories, prototype manufacture as well as measurement and testing equipment. Moreover, PI Ceramic works with leading universities and research institutions at home and abroad in the field of piezoelectricity.

Flexible Production

In addition to the broad spectrum of standard products, a top priority is the fastest possible implementation of custom-engineered solutions. Our pressing and multilayer technology enables us to shape products with a short lead time. We are able to manufacture individual prototypes as well as high-volume production runs. All processing steps are undertaken in-house and are subject to continuous controls, a process which ensures quality and adherence to deadlines.

Core Competences of PI Ceramic

- Standard piezo components for actuator, ultrasonic and sensor application
- System solutions
- Manufacturing of piezoelectric components of up to several 1,000,000 pieces per year
- Development of customized solutions
- High degree of flexibility in the engineering process, short lead times, manufacture of individual units and very small quantities
- All key technologies and state-of-the-art equipment for ceramic production in-house
- Certified in accordance with ISO 9001, ISO 14001 and OHSAS 18001

Company building of PI Ceramic in Lederhose, Thuringia, Germany.



Reliability and Close Contact with our Customers

OUR MISSION



PI Ceramic provides

- Piezoceramic materials (PZT)
- Piezoceramic components
- Customer- and application-specific transducers
- PICMA® monolithic multilayer piezo actuators
- Miniature piezo actuators
- PICMA® multilayer bending actuators
- PICA high-load piezo actuators
- Piezo tube actuators
- Preloaded actuators with casing
- Piezocomposites – DuraAct patch transducers

Our aim is to maintain high, tested quality for both our standard products and for custom-engineered components. We want you, our customers, to be satisfied with the performance of our products. At PI Ceramic, customer service starts with an initial informative discussion and extends far beyond the shipping of the products.

Advice from Piezo Specialists

You want to solve complex problems – we won't leave you to your own devices. We use our years of experience in planning, developing, designing and the production of individual solutions to accompany you from the initial idea to the finished product.

We take the time necessary for a detailed understanding of the issues and work out a comprehensive and optimum solution at an early stage with either existing or new technologies.

After-Sales Service

Even after the sale has been completed, our specialists are available to you and can advise you on system upgrades or technical issues.

This is how we at PI Ceramic achieve our objective: Long-lasting business relations and a trusting communication with customers and suppliers, both of which are more important than any short-term success.

PI Ceramic supplies piezo-ceramic solutions to all important high-tech markets:

- Industrial automation
- Semiconductor technology
- Medical technology
- Mechanical and precision engineering
- Aviation and aerospace
- Automotive industry
- Telecommunications

Experience and Know-How

STATE-OF-THE-ART MANUFACTURING TECHNOLOGY

Developing and manufacturing piezo-ceramic components are very complex processes. PI Ceramic has many years of experience in this field and has developed sophisticated manufacturing methods. Its machines and equipment are state of the art.

Rapid Prototyping

The requirements are realized quickly and flexibly in close liaison with the customer. Prototypes and small production runs of custom-engineered piezo components are available after very short processing times. The manufacturing conditions, i.e. the composition of the material or the sintering temperature, for example, are individually adjusted to the ceramic material in order to achieve optimum material parameters.

Precision Machining Technology

PI Ceramic uses machining techniques from the semiconductor industry to machine the sensitive piezoceramic elements with a

particularly high degree of precision. Special milling machines accurately shape the components when they are still in the "green state", i.e. before they are sintered. Sintered ceramic blocks are machined with precision saws like the ones used to separate individual wafers. Very fine holes, structured ceramic surfaces, even complex, three-dimensional contours can be produced.

Automated Series Production – Advantage for OEM Customers

An industrial application often requires large quantities of custom-engineered components. At PI Ceramic, the transition to large production runs can be achieved in a reliable and low-cost way while maintaining the high quality of the products. PI Ceramic has the capacity to produce and process medium-sized and large production runs in linked automated lines. Automatic screen printers and the latest PVD units are used to metallize the ceramic parts.



Automated processes optimize throughput

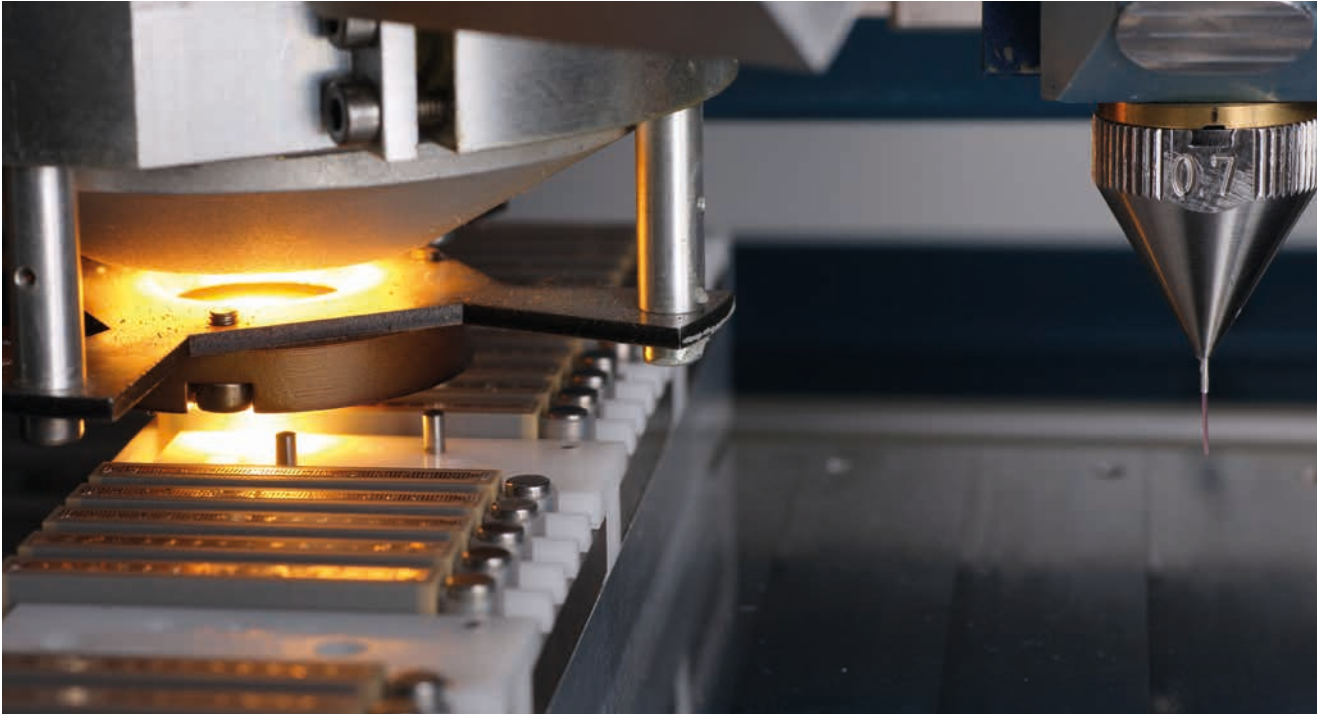

PICMA® Stack Multilayer Piezo Actuators

CERAMIC-INSULATED HIGH-POWER ACTUATORS



P-882 – P-888

- Superior lifetime
- High stiffness
- UHV-compatible to 10^{-9} hPa
- Microsecond response
- Sub-nanometer resolution
- Large choice of designs

Patented PICMA® Stack Multilayer Piezo Actuators with High Reliability

Operating voltage -20 to 120 V. Ceramic insulation, polymer-free. Humidity resistance. UHV-compatible to 10^{-9} hPa, no outgassing, high bakeout temperature. Encapsulated versions for operation in splash water or oil

Custom Designs with Modified Specifications

- For high operating temperature up to 200°C
- Special electrodes for currents of up to 20 A
- Variable geometry: Inner hole, round, rectangular
- Ceramic or metal end pieces in many versions
- Applied SGS sensors for positional stability

Fields of Application

Research and industry. Cryogenic environment with reduced displacement. For high-speed switching, precision positioning, active and adaptive systems

Suitable Drivers

E-610 Piezo Amplifier / Controller
E-617 High-Power Piezo Amplifier
E-831 OEM Piezo Amplifier Module

Valid Patents

German Patent No. 10021919C2
German Patent No. 10234787C1
German Patent No. 10348836B3
German Patent No. 102005015405B3
German Patent No. 102007011652B4
US Patent No. 7,449,077
Japan Patent No. 4667863
China Patent No. ZL03813218.4

Order number*	Dimensions A x B x L [mm]	Nominal displacement [μm] (0 – 100 V)	Max. displacement [μm] (0 – 120 V)	Blocking force [N] (0 – 120 V)	Stiffness [N/μm]	Electrical capacitance [μF] ±20%	Resonant frequency [kHz] ±20%
P-882.11	3 × 2 × 9	6.5 ±20%	8 ±20%	190	24	0.15	135
P-882.31	3 × 2 × 13.5	11 ±20%	13 ±20%	210	16	0.22	90
P-882.51	3 × 2 × 18	15 ±10%	18 ±10%	210	12	0.31	70
P-883.11	3 × 3 × 9	6.5 ±20%	8 ±20%	290	36	0.21	135
P-883.31	3 × 3 × 13.5	11 ±20%	13 ±20%	310	24	0.35	90
P-883.51	3 × 3 × 18	15 ±10%	18 ±10%	310	18	0.48	70
P-885.11	5 × 5 × 9	6.5 ±20%	8 ±20%	800	100	0.6	135
P-885.31	5 × 5 × 13.5	11 ±20%	13 ±20%	870	67	1.1	90
P-885.51	5 × 5 × 18	15 ±10%	18 ±10%	900	50	1.5	70
P-885.91	5 × 5 × 36	32 ±10%	38 ±10%	950	25	3.1	40
P-887.31	7 × 7 × 13.5	11 ±20%	13 ±20%	1700	130	2.2	90
P-887.51	7 × 7 × 18	15 ±10%	18 ±10%	1750	100	3.1	70
P-887.91	7 × 7 × 36	32 ±10%	38 ±10%	1850	50	6.4	40
P-888.31	10 × 10 × 13.5	11 ±20%	13 ±20%	3500	267	4.3	90
P-888.51	10 × 10 × 18	15 ±10%	18 ±10%	3600	200	6.0	70
P-888.91	10 × 10 × 36	32 ±10%	38 ±10%	3800	100	13.0	40

* For optional solderable contacts, change order number extension to .x0 (e. g. P-882.10).

Piezo ceramic type: PIC252.
Standard electrical interfaces: PTFE-insulated wire leads, 100 mm, P-882, P-883:

AWG 32 (Ø 0.49 mm); P-885, P-887, P-888: AWG 30 (Ø 0.61 mm).
Recommended preload for dynamic operation: 15 MPa.
Maximum preload for constant force: 30 MPa.

Resonant frequency at 1 V_{pp} unloaded, free on both sides. The value is halved for unilateral clamping.
Capacitance at 1 V_{pp}, 1 kHz, RT.
Operating voltage: -20 to 120 V.

Operating temperature range: -40 to 150°C.
Custom designs or different specifications on request.

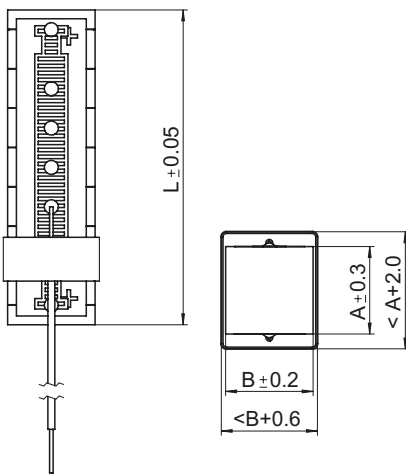

PICMA® Stack actuators, L, A, B see table

Custom Designs

PICMA® STACK PIEZO ACTUATORS



Variety of Tips

Spherical tips. PI Ceramic has suitable tips with standard dimensions in stock and mounts them prior to delivery. Application-specific tips can be manufactured on request.

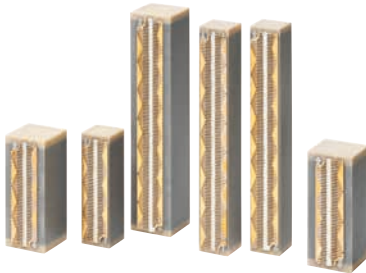

PICMA® Actuators for Maximum Dynamics

For high-dynamics applications, the multilayer actuators are equipped with electrodes for especially high currents of up to 20 A. Together with a high-performance switching driver such as the E-618, high operating frequencies in the kHz range can be attained. The rise times for the nominal displacement are a few tens of microseconds.

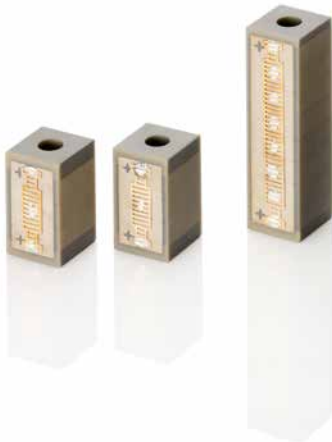

PICMA® Multilayer Actuators with Ceramic-Insulated Inner Hole

A new technology allows multilayer piezo actuators to be manufactured with an inner hole. Using special manufacturing methods the holes are already made in the unsintered actuator. As with the PICMA® standard actuators, the co-firing process of the ceramics and the internal electrodes is used to create the ceramic encapsulation which protects the piezo actuator against humidity and considerably increases its lifetime compared to conventional polymer-insulated piezo actuators. PICMA® stack actuators with an inner hole are ideally suited for applications such as fiber stretching. PICMA® actuators with holes are manufactured on request.

High Operating Temperature of up to 200°C

For especially high-dynamics applications or high ambient temperatures, there are PICMA® multilayer actuator versions that can reliably function at temperatures of up to 200°C.

Encapsulated PICMA[®] Stack Piezo Actuators

FOR TOUGH INDUSTRIAL ENVIRONMENTS



P-885 • P-888

- Splash-resistant full encapsulation
- Superior lifetime
- High stiffness
- UHV-compatible to 10⁻⁹ hPa
- Microsecond response
- Sub-nanometer resolution
- Large choice of designs

Encapsulated PICMA[®] Stack Multilayer Piezo Actuators with Inert Gas Filling

Operating voltage -20 to 120 V. UHV-compatible to 10⁻⁹ hPa. Version for operation in environments where exposure to splash water, high humidity or oil occurs

Order number*	Dimensions OD x L [mm]	Nominal displacement [μm] (0 – 100 V)	Max. displacement [μm] (0 – 120 V)	Blocking force [N] (0 – 120 V)	Stiffness [N/μm]	Electrical capacitance [μF] ±20%	Resonant frequency [kHz] ±20%
P-885.55	11.2 × 22.5	14 ±10%	17 ±10%	850	50	1.5	60
P-885.95	11.2 × 40.5	30 ±10%	36 ±10%	900	25	3.1	35
P-888.55	18.6 × 22.5	14 ±10%	17 ±10%	3400	200	6.0	60

Piezo ceramic type: PIC252.
Standard electrical interfaces: PTFE-insulated wire leads, 100 mm, AWG 30 (Ø 0.61 mm).
Resonant frequency at 1 V_{pp}, unloaded, free on both sides. The value is halved for unilateral

clamping. Capacitance at 1 V_{pp}, 1 kHz, RT. Operating voltage: -20 to 120 V. Operating temperature range: -40 to 150°C. Ask about custom designs!

	A [mm]	B [mm]	C [mm]
P-885.XX	6.40	11.00	10.25
P-888.XX	12.00	17.50	16.85

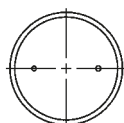
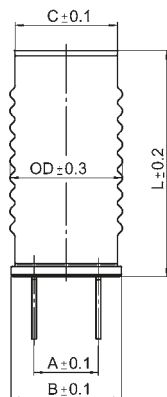

Encapsulated PICMA[®] actuators, dimensions in mm

Encapsulated PICMA[®] Stack actuators can also be used when the application environment is characterized by oil, splash water or continuously high humidity. The piezo actuators are surrounded by inert gas

Round PICMA[®] Stack Multilayer Piezo Actuator

HIGH BLOCKING FORCE

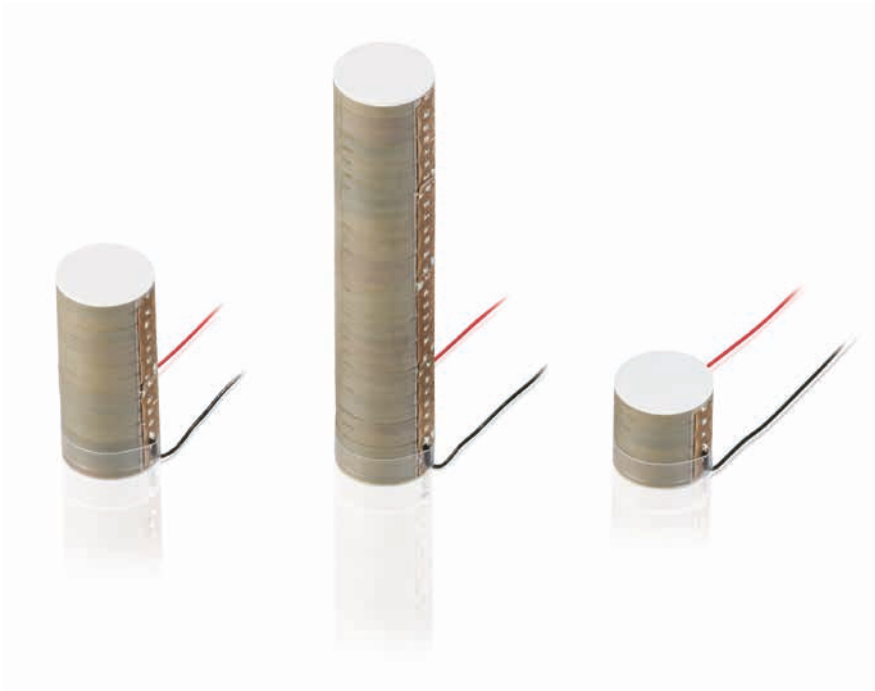

P-088

- Superior lifetime
- Ideal for dynamic operation
- Flexible, adaptable overall height
- OEM versions available without stranded wires

Multilayer stack actuators

The actuators are easily scaled, thanks to the stacked construction, flexible adaptation of the travel range is possible. The annular cross section ensures easy integration. Versions with solderable contacts are also UHV-compatible to 10^{-9} hPa. The actuators do not outgas and can be baked out at high temperatures.

PICMA[®] piezo linear actuators

Low operating voltage -20 to 100 V. Ceramic insulation. High reliability and long lifetime

Possible modifications

Different heights, easy to mount on customer request. Variety of shapes. Precision-ground end plates for reduced tolerances Spherical end pieces

Fields of application

Industry and research. For laser tuning, microdispensing, life sciences

	P-088.721	P-088.741	P-088.781	Unit	Tolerance
Dimensions OD x L	16 x 16	16 x 36	16 x 77	mm	
Nominal travel range	14	32	70	μm	-10 % / + 20 %
Blocking force	7500	7500	7500	N	
Stiffness	535	235	105	N/ μm	
Electrical capacitance	13	30	68	μF	$\pm 20\%$
Resonant frequency	68	35	17	kHz	$\pm 20\%$

Nominal travel range, blocking force and stiffness at 0 to 100 V.

Standard connections: 100 mm PTFE- insulated stranded wires, AWG 28 (\varnothing 0.69 mm). Optional: For solderable contacts without stranded wires, change the last digit of the order number to 0.

Piezo ceramic type: PIC252. ceramic end plates made of Al_2O_3 .

Recommended preload for dynamic operation: 15 MPa.

Maximum preload for constant force: 30 MPa.

Axial resonant frequency: measured at $1 V_{pp}$, unloaded, unclamped. The value is halved for unilateral clamping.

Electrical capacitance: measured at $1 V_{pp}$, 1 kHz, RT

Operating voltage: -20 to 100 V.

Operating temperature range: -40 to 150 °C.

Ask about custom designs!

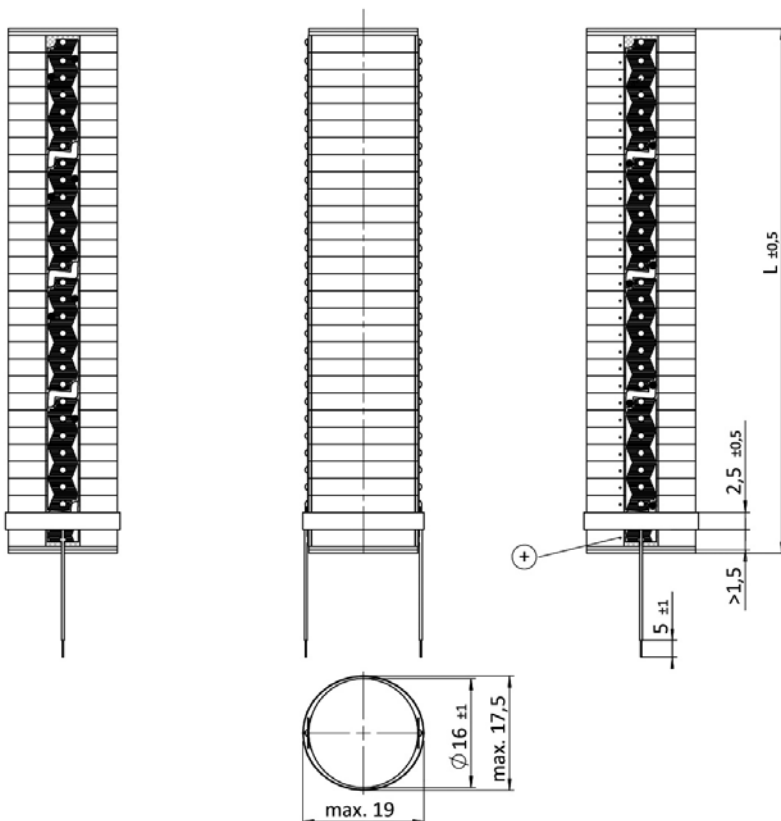

P-088 PICMA® Stack Multilayer Piezo Actuator, dimensions in mm

PICMA® Stack Multilayer Ring Actuator

WITH INNER HOLE

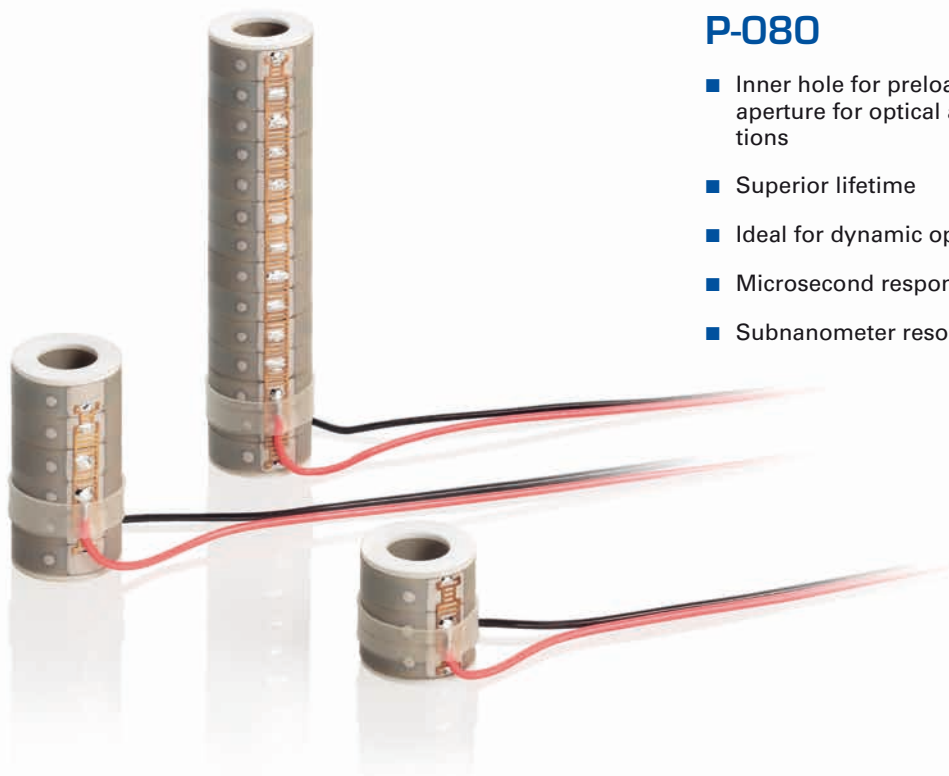

P-080

- Inner hole for preload or as aperture for optical applications
- Superior lifetime
- Ideal for dynamic operation
- Microsecond response
- Subnanometer resolution

Multilayer Stack Actuators

Flexible travel range up to 30 μm . Annular cross-section for easy integration.
UHV-compatible to 10^{-9} hPa, high bakeout temperature

PICMA® Piezo Linear Actuators

Low operating voltage -20 to 100 V. Ceramic insulation.
High reliability and long lifetime

Available Options

Different heights, easy to mount on customer request.
Variety of shapes. Precision-ground end plates for reduced tolerances

Fields of Application

Research and industry. For laser tuning, micro-dispensing, life sciences

Preliminary data	P-080.311	P-080.341	P-080.391	Unit
Dimensions OD × ID × L	8 × 4.5 × 8.5	8 × 4.5 × 16	8 × 4.5 × 36	mm × mm × mm
Nominal travel range	5.5 ±20 %	11 ±20 %	25 ±10 %	μm
Blocking force	800	825	850	N
Stiffness	145	75	34	N/μm
Electrical capacitance	0.86	1.7	4.0	μF
Resonant frequency	135 ±20 %	85 ±20 %	40 ±20 %	kHz

All data at 0 to 100 V.

Standard connections: PTFE-insulated stranded wires, 100 mm, AWG 30 (Ø 0.61 mm).

For optional solderable contacts without stranded wires, change order number extension to 0.

Piezo ceramic type PIC252. Ceramic end plates made of Al₂O₃.

Recommended preload for dynamic operation: 15 MPa.

Maximum preload for constant force: 30 MPa.

Axial resonant frequency: measured at 1 V_{pp}, unloaded, unclamped.

The value is halved for unilateral clamping.

Electrical capacitance: Tolerance ±20%, measured at 1 V_{pp}, 1 kHz, RT.

Operating voltage: -20 to 100 V.

Operating temperature range: -40 to 150°C.

Ask about custom designs!

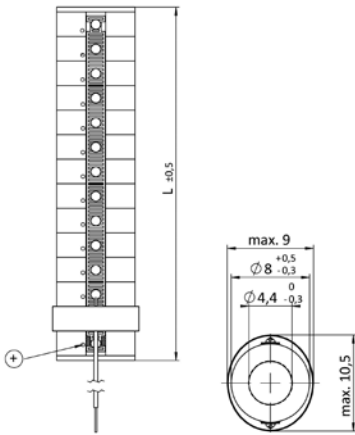

P-080, dimensions in mm

Round PICMA[®] Chip Actuators

MINIATURE MULTILAYER PIEZO ACTUATOR WITH AND WITHOUT INNER HOLE



PDOxx

- Superior lifetime
- Ultra-compact: From 5 mm Ø
- Ideal for dynamic operation
- Microsecond response
- Subnanometer resolution

Piezo linear actuator with PICMA[®] multilayer technology

Operating voltage -20 to 100 V. Ceramic insulation, polymer-free. Humidity resistance. UHV-compatible to 10^{-9} hPa, no outgassing, high bakeout temperature.

Flexible thanks to numerous designs. Versions with rectangular, round or annular cross section

Possible modifications

PTFE-insulated wire leads. Various geometric shapes, inner hole. Precision-ground ceramic end plates

Fields of application

Industry and research. For laser tuning, microdispensing, life sciences

	PD050.3x	PD080.3x	PD120.3x	PD150.3x	PD160.3x	PD161.3x	Unit	Tolerance
ID	5 ±0.2	8 ±0.3	12 ±0.4	15 ±0.3	16 ±0.5	16 ±0.5	mm	
OD	2.5 ±0.15	4.5 ±0.15	6 ±0.2	9 ±0.15	8 ±0.25	–	mm	
TH	2.5 ±0.05	2.5 ±0.05	2.5 ±0.05	2 ±0.05	2.5 ±0.05	2.5 ±0.05	mm	
Travel range*	2	2	2	1.8	2	2.3	µm	±20 %
Blocking force	>400	>1000	>2500	>3300	>4400	>6000	N	
Electrical capacitance**	110	300	900	1000	1700	2400	nF	±20 %
Axial resonant frequency***	>500	>500	>500	>500	>500	>500	kHz	

Standard connections: PDxxx.31: PTFE-insulated wire leads, 100 mm, AWG 32, Ø 0.49 mm; PDxxx.30: Solderable contacts

Blocking force: At 0 to 100 V

* At 0 to 100 V. The values refer to the unattached component and can be lower when glued on.

** measured at 1 V_{pp}, 1 kHz, RT

*** measure at 1 V_{pp}, unloaded, open on both sides. The value is halved for unilateral clamping. Lateral resonant frequencies can be lower than the axial ones, depending on the installation situation.

PICMA[®] Chip Actuators

MINIATURE MULTILAYER PIEZO ACTUATORS

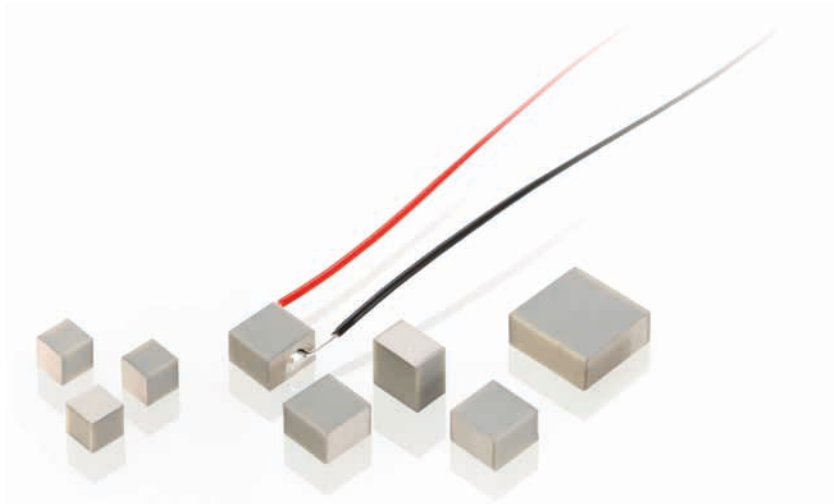

PLOxx

- Superior lifetime
- Ultra-compact: From 2 mm × 2 mm × 2 mm
- Ideal for dynamic operation
- Microsecond response
- Subnanometer resolution

Piezo linear actuator with PICMA[®] multilayer technology

Operating voltage -20 to 100 V. Ceramic insulation, polymer-free. Humidity resistance. UHV-compatible to 10⁻⁹ hPa, no outgassing, high bakeout temperature.

Large choice of designs. Versions with rectangular or annular cross-section

Available Options

PTFE-insulated wire leads. Various geometric shapes, inner hole. Precision-ground ceramic end plates

Fields of Application

Research and industry. For laser tuning, micro-dispensing, life sciences

	PL022.30	PL033.30	PL055.30	PL088.30	Unit
Dimensions A × B × TH	2 × 2 × 2	3 × 3 × 2	5 × 5 × 2	10 × 10 × 2	mm × mm × mm
Displacement	2.2	2.2	2.2	2.2	μm
Blocking force	>120	>300	>500	>2000	N
Electrical capacitance	25	75	250	1100	nF
Resonant frequency	>600	>600	>600	>600	kHz

Travel range: at 0 to 100 V, tolerance ±20 %. The values refer to the free component and can be lower when glued on.

Blocking force: at 0 to 100 V.

Electrical capacitance: Tolerance ±20 %, measured at 1 Vpp, 1 kHz, RT.

Axial resonant frequency: measured at 1 Vpp, unloaded, unclamped. The value is halved for unilateral clamping. Lateral resonant frequencies can be lower than the axial ones, depending on the installation situation.

Piezo ceramic type: PIC252.

Standard connections: PLxxx.31: PTFE-insulated wire leads, 100 mm, AWG 32, Ø 0.49 mm; PLxxx.30: Solderable contacts

Operating voltage: -20 to 100 V.

Operating temperature range: -40 to 150 °C.

Recommended preload for dynamic operation: 15 MPa.

Maximum preload for constant force: 30 MPa.

Ask about custom designs!

PICMA® Bender Piezo Actuator

ALL-CERAMIC BENDER ACTUATORS WITH HIGH DISPLACEMENT

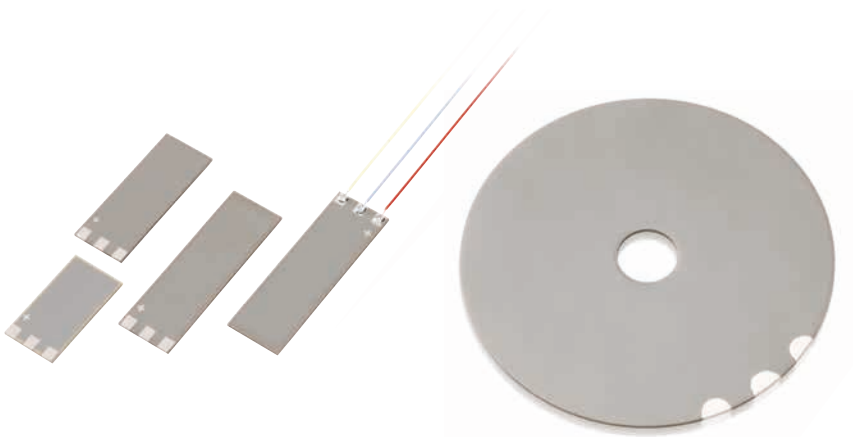

PL112 – PL140 • PD410

- Displacement to 2 mm
- Fast response in the ms range
- Nanometer resolution
- Low operating voltage

PICMA® Multilayer Bender Elements with High Reliability

Operating voltage 0 to 60 V. Bidirectional displacement. Ceramic insulation, polymer-free. UHV-compatible to 10^{-9} hPa, no outgassing, high bakeout temperature. Reliable even under extreme conditions

Fields of Application

Research and industry, vacuum. For medical technology, laser technology, sensor systems, automation tasks, pneumatic valves

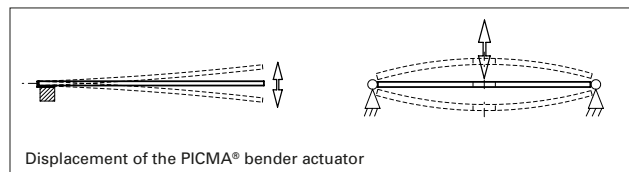

Displacement of the PICMA® bender actuator

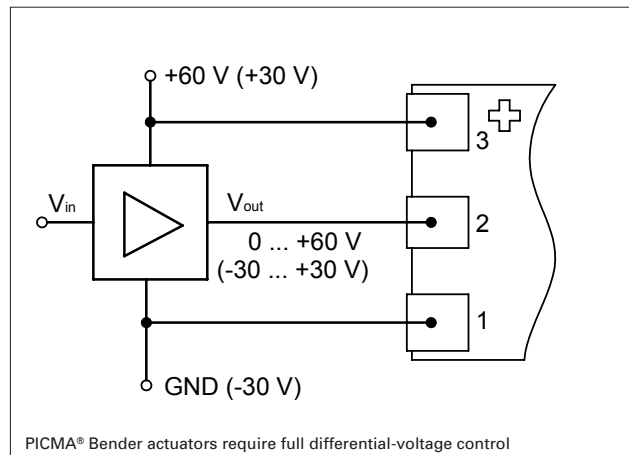

Suitable Drivers

E-650 Piezo Amplifier for Multilayer Bender Actuators

Rectangular bender actuators

Order number	Operating voltage [V]	Displacement [μm] $\pm 20\%$	Free length L_f [mm]	Dimensions $L \times W \times TH$ [mm]	Blocking force [N] $\pm 20\%$	Electrical capacitance [μF] $\pm 20\%$	Resonant frequency [Hz] $\pm 20\%$
PL112.10*	0 - 60 (± 30)	± 80	12	18.0 \times 9.6 \times 0.65	± 2.0	2 * 1.1	2000
PL122.10	0 - 60 (± 30)	± 250	22	25.0 \times 9.6 \times 0.65	± 1.1	2 * 2.4	660
PL127.10	0 - 60 (± 30)	± 450	27	31.0 \times 9.6 \times 0.65	± 1.0	2 * 3.4	380
PL128.10*	0 - 60 (± 30)	± 450	28	36.0 \times 6.3 \times 0.75	± 0.5	2 * 1.2	360
PL140.10	0 - 60 (± 30)	± 1000	40	45.0 \times 11.0 \times 0.6	± 0.5	2 * 4.0	160

Round bender actuators

Order number	Operating voltage [V]	Displacement [μm] $\pm 20\%$	Free length L_f [mm]	Dimensions $OD \times ID \times TH$ [mm]	Blocking force [N] $\pm 20\%$	Electrical capacitance [μF] $\pm 20\%$	Resonant frequency [Hz] $\pm 20\%$
PD410.10*	0 - 60 (± 30)	± 240	-	44 \times 7 \times 0.65	± 16	2 * 10.5	1000

For optional 100 mm PTFE-insulated wire leads, AWG 32 (\varnothing 0.49 mm), change order number extension to 1 (e. g. PL112.11).

Piezo ceramic type: PIC251, *PIC252.

Standard connections: Solderable contacts.

Resonant frequency at $1 V_{pp}$, clamped on one side with free length L_f , without mass load. For PD410.10: Restraint with rotatable mounting on the outer circumference.

Capacitance at $1 V_{pp}$, 1 kHz, RT.

Operating temperature range: -20 to 85°C; * -20 to 150°C.

Recommended mounting: Epoxy resin adhesive. All specifications depend on the real clamping conditions and on the applied mechanical load.

Custom designs or different specifications on request.

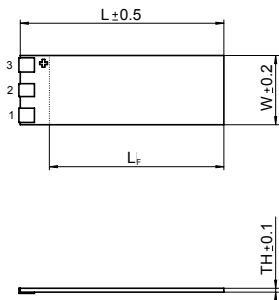

PL112 – PL140.10, dimensions in mm.
 L_f , W , TH see data table

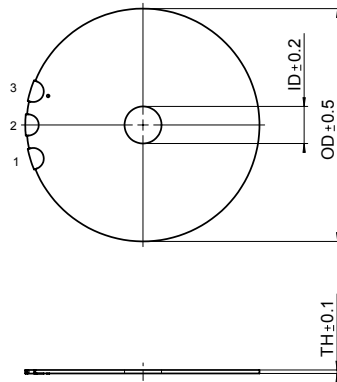

PD410 round PICMA® Bender Piezo Actuator, dimensions in mm. ID, OD, TH see data table

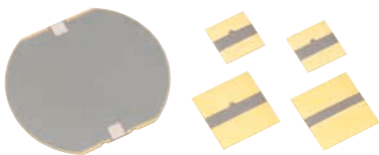

Multilayer contracting plates can be manufactured in a variety of shapes, e. g. rectangular or disk-shaped, and are available on request. These plates can be applied e. g. to metal or silicon substrates, in order to realize bender or pump elements with low control voltages.

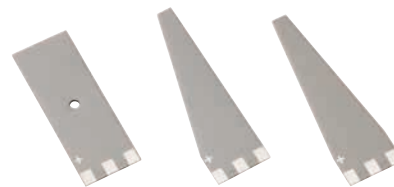

Multilayer bender actuators can be manufactured in almost any shape. The manufacturing process allows, among other things, inner holes with an all-ceramic insulation. The height of the active layers can be varied from a minimum height of 15 μm so that control voltages of only 10 V can be used.

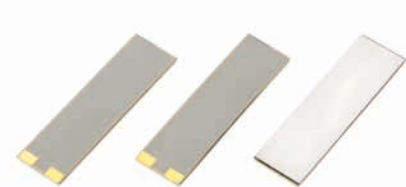

Benders with unidirectional displacement consist of a single active piezoceramic layer that is glued together with a substrate of Al_2O_3 ceramics or stainless steel. In comparison with the bimorph structure, these actuators achieve a higher stiffness and a greater displacement, which only takes place in one direction, however.

DuraAct Patch Transducer

BENDABLE AND ROBUST

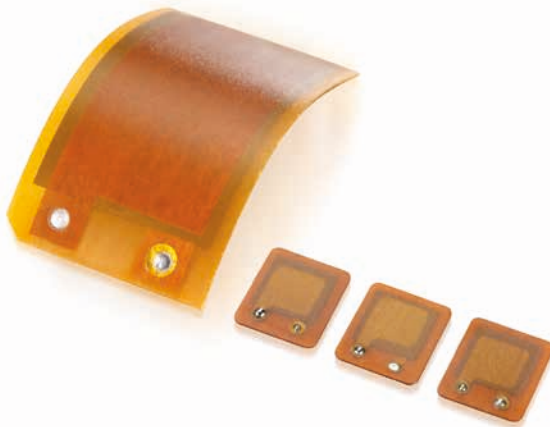

P-876

- Use as actuator, sensor or energy generator
- Cost-effective
- Min. bending radii of down to 12 mm

Patch Transducer

Functionality as actuator and sensor component. Nominal operating voltage from 100 up to 1000 V, depending on the active layer height. Power generation for self-sufficient systems possible up to the milliwatt range. Can also be applied to curved surfaces

Robust, Cost-Effective Design

Laminated structure consisting of a piezoceramic plate, electrodes and polymer materials. Manufactured with bubble-free injection method. The polymer coating simultaneously serves as a mechanical preload as well as an electrical insulation, which makes the DuraAct bendable

Custom DuraAct Patch Transducers

- Flexible choice of size
- Flexible choice of thickness and thus bending ability
- Flexible choice of piezoceramic material
- Variable design of the electrical connections
- Combined actuator/sensor applications, even with several piezoceramic layers
- Multilayer piezo elements
- Arrays

Fields of Application

Research and industry. Can also be applied to curved surfaces or used for integration in structures. For adaptive systems, energy harvesting, structural health monitoring

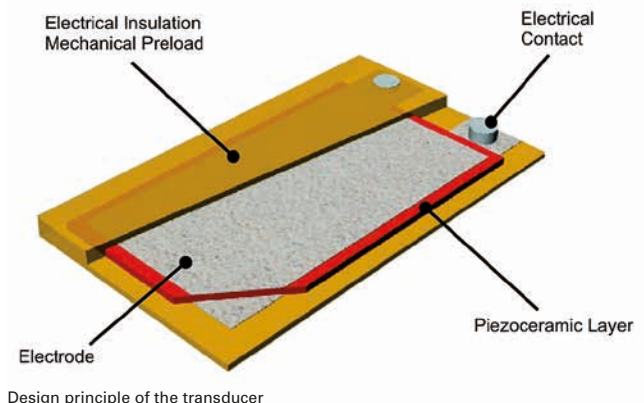

Valid Patents

German Patent No. 10051784C1
US Patent No. 6,930,439

Suitable Drivers

E-413 DuraAct and PICA Shear Piezo Amplifier
E-835 DuraAct Piezo Driver

Order Number	Operating voltage [V]	Min. lateral contraction [$\mu\text{m}/\text{m}$]	Rel. lateral contraction [$\mu\text{m}/\text{m}/\text{V}$]	Blocking force [N]	Dimensions [mm]	Min. bending radius [mm]	Piezo ceramic height [μm]	Electrical capacitance [nF] $\pm 20\%$
P-876.A11	-50 to +200	400	1.6	90	61 × 35 × 0.4	12	100	150
P-876.A12	-100 to +400	650	1.3	265	61 × 35 × 0.5	20	200	90
P-876.A15	-250 to +1000	800	0.64	775	61 × 35 × 0.8	70	500	45
P-876.SP1	-100 to +400	650	1.3	n.a.	16 × 13 × 0.5	-	200	8

Piezo ceramic type: PIC255

Standard connections: Solder pads

Operating temperature range: -20 to 150°C

Custom designs or different specifications on request.

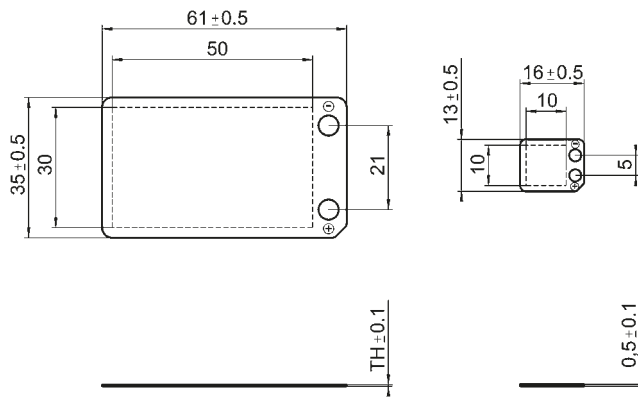

P-876.A (left), P-876.SP1 (right), dimensions in mm

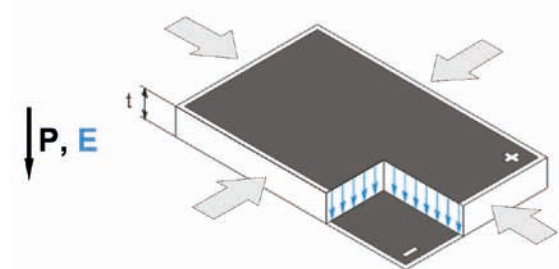

When a voltage is applied, the DuraAct patch transducer contracts laterally. P-876 DuraAct patch transducers use the so-called d_{31} effect, where the applied field is orthogonal with respect to the polarization of the piezo element.

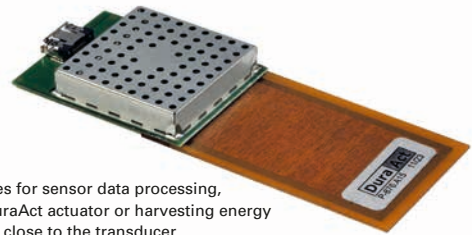

Electronic modules for sensor data processing, controlling the DuraAct actuator or harvesting energy can be connected close to the transducer

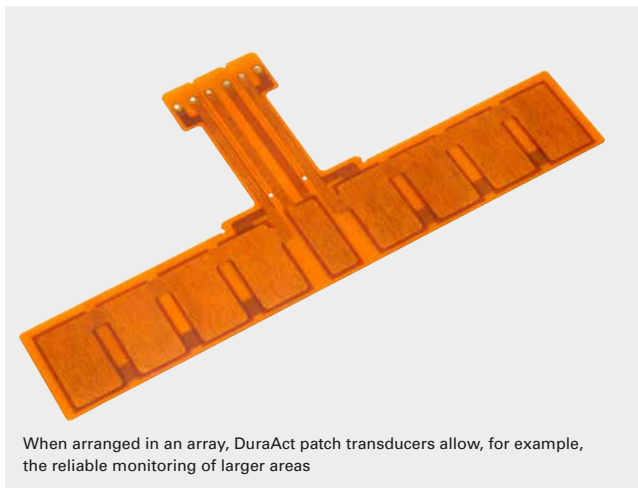

When arranged in an array, DuraAct patch transducers allow, for example, the reliable monitoring of larger areas

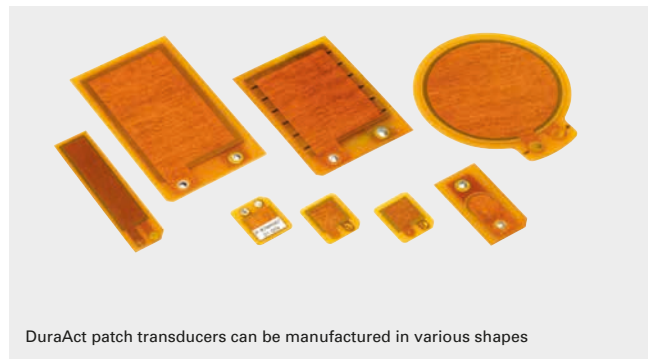

DuraAct patch transducers can be manufactured in various shapes

DuraAct Power Patch Transducer

HIGH EFFICIENCY AND ROBUST

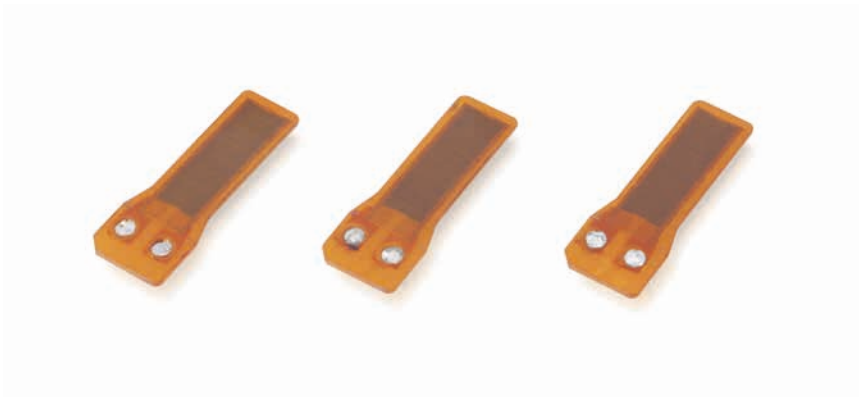

P-878

- Useable as actuator, sensor or energy generator
- Low voltages to 120 V
- Compact design
- Individual solutions

Patch Transducer

Functionality as actuator and sensor component. Nominal operating voltages of -20 to 120 V. Power generation for self-sufficient systems possible up to the milliwatt range. Can also be applied to curved surfaces.

In longitudinal direction, the DuraAct Power uses the high-efficiency d_{33} effect

Robust, Cost-Effective Design

Laminated structure consisting of PICMA® multilayer piezo element, electrodes and polymer materials. Manufactured with bubble-free injection method. The polymer coating simultaneously serves as electrical insulation and as mechanical preload, which makes the DuraAct bendable

Custom DuraAct Patch Transducers

- Flexible choice of size
- Variable design of the electrical connections
- Combined actuator/sensor applications, even with several active piezoceramic layers
- Arrays

Fields of Application

Research and industry. Can also be applied to curved surfaces or used for integration in structures. For adaptive systems, energy harvesting, structural health monitoring

Preliminary data	P-878.A1	Unit
Min. axial strain	1200	$\mu\text{m}/\text{m}$
Rel. axial strain	10	$\mu\text{m}/\text{V}$
Min. lateral contraction	250	$\mu\text{m}/\text{m}$
Rel. lateral contraction	1.2	$\mu\text{m}/\text{V}$
Blocking force	44	N
Dimensions	27 mm \times 9.5 mm \times 0.5 mm	
Min. bending radius	24	mm
Active element	15 mm \times 5.4 mm	
Electrical capacitance	150	nF

Electrical capacitance: Tolerance $\pm 20\%$, measured at $1 V_{pp}$, 1 kHz, RT.

Piezo ceramic type: PIC 252.

Standard connections: Solderable contacts.

Operating voltage: -20 to 120 V.

Operating temperature range: -20 to 150°C.

Custom designs or different specifications on request.

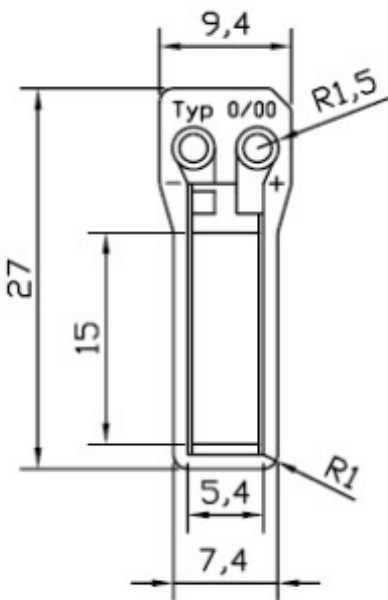

P-878.A1, dimensions in mm

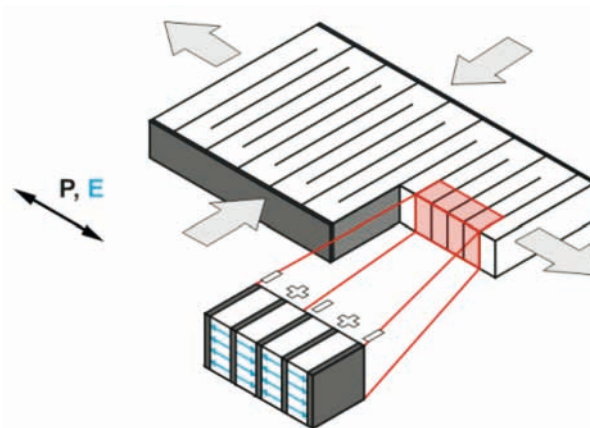

DuraAct Power Multilayer Patch Transducers use the longitudinal or d_{33} effect, which describes an elongation parallel to the electric field E and the polarization direction P of the piezo actuator. The d_{33} piezoelectric charge coefficients for longitudinal displacement are considerably higher than the d_{31} coefficients for transversal displacement, used by all-ceramic patch transducers. (Source: Wierach, DLR)

PT Piezo Tube Actuators

HIGH-DYNAMICS OPERATION WITH LOW LOADS



PT120 – PT140

- Radial, lateral and axial displacement
- Sub-nanometer resolution
- Ideal for OEM applications
- Large choice of designs

Piezo Actuator / Scanner Tube

Operating voltage of up to 1000 V or bipolar up to ± 250 V. Monolithic piezoceramic actuator with minimal geometric tolerances. Radial and axial contraction, low load capacity. UHV-compatible versions with multi-segmented electrodes

Custom Designs with Modified Specifications

- Materials
- Operating voltage range, displacement
- Tolerances
- Applied sensors
- Special high / low temperature versions
- Geometric shapes: Rectangular, inner hole
- Segmentation of the electrodes, wrap-around electrodes, circumferential insulating borders
- Non-magnetic

Possible Dimensions

- Length L max. 70 mm
- Outer diameter OD 2 to 80 mm
- Inner diameter ID 0.8 to 74 mm
- Min. wall thickness 0.30 mm



Special versions of the PT Piezo Scanner Tubes with multi-segmented outer electrodes and wrap-around electrodes

Fields of Application

Research and industry, UHV environment up to 10^{-9} hPa. For microdosing, micromanipulation, scanning microscopy (AFM, STM, etc.), fiber stretching

Order Number	Dimensions [mm] L x OD x ID	Max. operating voltage [V]	Electrical capacitance [nF] $\pm 20\%$	Max. change in contraction [μm]	Max. diameter contraction [μm]
PT120.00	20 x 2.2 x 1.0	500	3	5	0.7
PT130.90	30 x 3.2 x 2.2	500	12	9	0.9
PT130.10	30 x 6.35 x 5.35	500	18	9	1.8
PT130.20	30 x 10.0 x 9.0	500	36	9	3
PT130.40	30 x 20.0 x 18.0	1000	35	9	6
PT140.70	40 x 40.0 x 38.0	1000	70	15	12

Max. displacement data refers to respective max. operating voltage.

Piezo ceramic type: PIC151

Capacitance at $1 V_{pp}$, 1 kHz, RT.

Inner electrode on positive potential, fired-silver electrodes inside and outside as standard. Option: Outer electrode thin film (CuNi, Au).

Scanner Tubes

Quartered electrodes for XY deflection, UHV-compatible to 10^{-9} hPa

Order Number	Dimensions [mm] L x OD x ID	Max. operating voltage [V]	Electrical capacitance [nF] $\pm 20\%$	Max. change in length [μm]	Max. XY displacement [μm]
PT230.94	30 x 3.2 x 2.2	± 250	4 x 2.1	± 4.5	± 35
PT230.14	30 x 6.35 x 5.35	± 250	4 x 4.5	± 4.5	± 16
PT230.24	30 x 10.0 x 9.0	± 250	4 x 6.9	± 4.5	± 10

Max. displacement data refers to respective max. operating voltage. Max. XY displacement for simultaneous control with +250 / -250 V at opposite electrodes.

Piezo ceramic type: PIC255. Operating temperature range: -20 to 85°. Bakeout temperature up to 150°C.

Capacitance at $1 V_{pp}$, 1 kHz, RT.

Quartered electrodes for XY deflection. Outer electrode thin film (CuNi, Au), inner electrodes fired-silver.

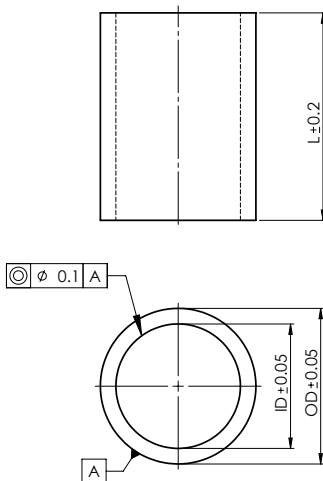

PT Piezo Tube actuators, dimensions in mm. L, OD, ID see data table

PICA Stack Piezo Actuators

HIGH FORCES, HIGH DISPLACEMENT, FLEXIBLE PRODUCTION



P-007 – P-056

- Travel ranges to 300 μm
- High load capacity
- Force generation up to 80 kN
- Extreme reliability: $>10^9$ cycles
- Microsecond response
- Sub-nanometer resolution
- Large choice of designs

Stacked Piezo Linear Actuator

Operating voltage 0 to 1000 V. Long lifetime without derating. High specific displacement. High forces. Operating temperature range -20 to 85°C

Available Options

- SGS sensors for positional stability
- PZT ceramic material
- Operating voltage range, displacement, layer thickness
- Load capacity, force generation
- Geometric shapes: Round, rectangular
- Mechanical interfaces: Flat, spherical, metal, ceramic, glass, sapphire, etc.
- Integrated piezoelectric detector layers
- Special high / low temperature versions, temperature sensor
- Non-magnetic versions
- Extra-tight length tolerances

Fields of Application

Research and industry. For high-load positioning, precision mechanics / -machining, switches



Custom actuator with special end piece and applied SGS sensors. The protective polymer layer can be dyed in different colors. Standard versions are delivered with stranded wires and are covered in black

Suitable Drivers

E-464 PICA Piezo Driver
E-481 PICA High-performance Piezo Driver / Controller
E-470 • E-472 • E-421 PICA Controller

Order number	Displacement (0–1000 V) [μm] -10/+20%	Diameter OD [mm]	Length L [mm] ±0,5	Blocking force (0–1000 V) [N]	Stiffness [N/μm]	Capacitance [nF] ±20%	Resonant frequency [kHz]
P-007.00	5	7	8	650	130	11	126
P-007.10	15	7	17	850	59	33	59
P-007.20	30	7	29	1000	35	64	36
P-007.40	60	7	54	1150	19	130	20
P-010.00	5	10	8	1400	270	21	126
P-010.10	15	10	17	1800	120	64	59
P-010.20	30	10	30	2100	71	130	35
P-010.40	60	10	56	2200	38	260	20
P-010.80	120	10	107	2400	20	510	10
P-016.10	15	16	17	4600	320	180	59
P-016.20	30	16	29	5500	190	340	36
P-016.40	60	16	54	6000	100	680	20
P-016.80	120	16	101	6500	54	1300	11
P-016.90	180	16	150	6500	36	2000	7
P-025.10	15	25	18	11000	740	400	56
P-025.20	30	25	30	13000	440	820	35
P-025.40	60	25	53	15000	250	1700	21
P-025.80	120	25	101	16000	130	3400	11
P-025.90	180	25	149	16000	89	5100	7
P-025.150	250	25	204	16000	65	7100	5
P-025.200	300	25	244	16000	54	8500	5
P-035.10	15	35	20	20000	1300	700	51
P-035.20	30	35	32	24000	810	1600	33
P-035.40	60	35	57	28000	460	3300	19
P-035.80	120	35	104	30000	250	6700	11
P-035.90	180	35	153	31000	170	10000	7
P-045.20	30	45	33	39000	1300	2800	32
P-045.40	60	45	58	44000	740	5700	19
P-045.80	120	45	105	49000	410	11000	10
P-045.90	180	45	154	50000	280	17000	7
P-050.20	30	50	33	48000	1600	3400	32
P-050.40	60	50	58	55000	910	7000	19
P-050.80	120	50	105	60000	500	14000	10
P-050.90	180	50	154	61000	340	22000	7
P-056.20	30	56	33	60000	2000	4300	32
P-056.40	60	56	58	66000	1100	8900	19
P-056.80	120	56	105	76000	630	18000	10
P-056.90	180	56	154	78000	430	27000	7

Piezo ceramic type: PIC151
Standard electrical interfaces:
FEP-insulated wire leads, 100 mm,
AWG 24 (Ø 1.15 mm).
Recommended preload for
dynamic operation: 15 MPa.

Maximum preload for constant force:
30 MPa.
Resonant frequency at $1 V_{pp}$, unloaded,
free on both sides. The value is halved
for unilateral clamping.
Capacitance at $1 V_{pp}$, 1 kHz, RT.

Operating voltage: 0 to 1000 V.
Operating temperature range: -20
to 85°C.
Standard mechanical interfaces: Steel
or titanium plates, 0.5 to 1.0 mm thick
(depends on model).

Outer surfaces: Polyolefin shrink
sleeving, black. Custom designs
or different specifications on
request.

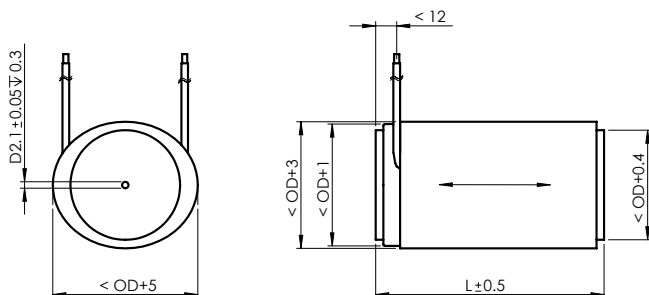

PICA Stack, dimensions in mm. L, OD see data table

PICA Power Piezo Actuators

FOR HIGH-DYNAMICS APPLICATIONS



P-010.xxP – P-056.xxP

- Operating temperature up to 150°C
- High operating frequencies
- High load capacity
- Force generation up to 70 kN
- Microsecond response
- Sub-nanometer resolution
- Large choice of designs

Stacked Piezo Linear Actuator

Operating voltage 0 to 1000 V. Long lifetime without performance loss. Large displacement, low electrical capacitance. Integrated temperature sensor to prevent damage from overheating. Extreme reliability: $>10^9$ cycles

Available Options

- Bipolar control
- SGS sensors for positional stability
- PZT ceramic material
- Operating voltage range, displacement, layer thickness
- Load capacity, force generation
- Geometric shapes: Rectangular, inner hole
- Mechanical interfaces: Flat, metal, ceramic, glass, sapphire, etc.
- Integrated piezoelectric detector layers
- Operating temperature of up to 200°C
- UHV-compatible to 10^{-9} hPa
- Non-magnetic versions
- Extra-tight length tolerances

Fields of Application

Research and industry. For active damping of oscillations, precision mechanics / -machining, active structures (adaptive systems technology)

Suitable Drivers

E-481 PICA High-performance Piezo Driver / Controller
E-470 • E-472 • E-421 PICA Controller
E-464 PICA Piezo Driver

Order number	Displacement [μm] (0–1000 V) -10/+20%	Diameter OD [mm]	Length L [mm] ± 0.5	Blocking force (0–1000 V) [N]	Stiffness [N/ μm]	Capacitance [nF] $\pm 20\%$	Resonant frequency [kHz]
P-010.00P	5	10	9	1200	240	17	129
P-010.10P	15	10	18	1800	120	46	64
P-010.20P	30	10	31	2100	68	90	37
P-010.40P	60	10	58	2200	37	180	20
P-010.80P	120	10	111	2300	19	370	10
P-016.10P	15	16	18	4500	300	130	64
P-016.20P	30	16	31	5400	180	250	37
P-016.40P	60	16	58	5600	94	510	20
P-016.80P	120	16	111	5900	49	1000	10
P-016.90P	180	16	163	6000	33	1600	7
P-025.10P	15	25	20	9900	660	320	58
P-025.20P	30	25	33	12000	400	630	35
P-025.40P	60	25	60	13000	220	1300	19
P-025.80P	120	25	113	14000	120	2600	10
P-025.90P	180	25	165	14000	80	4000	7
P-035.10P	15	35	21	18000	1200	530	55
P-035.20P	30	35	34	23000	760	1200	34
P-035.40P	60	35	61	26000	430	2500	19
P-035.80P	120	35	114	28000	230	5200	10
P-035.90P	180	35	166	29000	160	7800	7
P-045.20P	30	45	36	36000	1200	2100	32
P-045.40P	60	45	63	41000	680	4300	18
P-045.80P	120	45	116	44000	370	8800	10
P-045.90P	180	45	169	45000	250	13000	7
P-056.20P	30	56	36	54000	1800	3300	32
P-056.40P	60	56	63	66000	1100	6700	18
P-056.80P	120	56	116	68000	570	14000	10
P-056.90P	180	56	169	70000	390	21000	7

Piezo ceramic type: PIC255.
Standard electrical interfaces: FEP-insulated wire leads, 100 mm, AWG 24 (\varnothing 1.15 mm). PT1000 temperature sensor.
Recommended preload for dynamic operation: 15 MPa.

Maximum preload for constant force: 30 MPa.
Resonant frequency at $1 V_{pp}$, unloaded. The value is halved for unilateral clamping.
Capacitance at $1 V_{pp}$, 1 kHz, RT.

Operating voltage: 0 to 1000 V.
Operating temperature range: -20 to 150°C. Standard mechanical interfaces: Steel or titanium plates, 0.5 to 1.0 mm thick (depends on model).
Outer surfaces: FEP, transparent shrink

sleeving (outside); epoxy resin (inside).
Custom designs or different specifications on request.

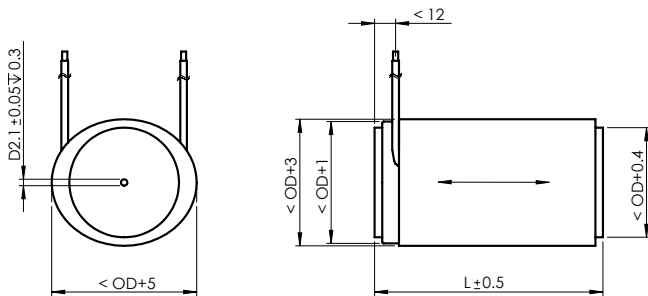

PICA Power, dimensions in mm. L, OD see data table

PICA Thru Ring Actuators

HIGH-LOAD PIEZO ACTUATORS WITH INNER HOLE

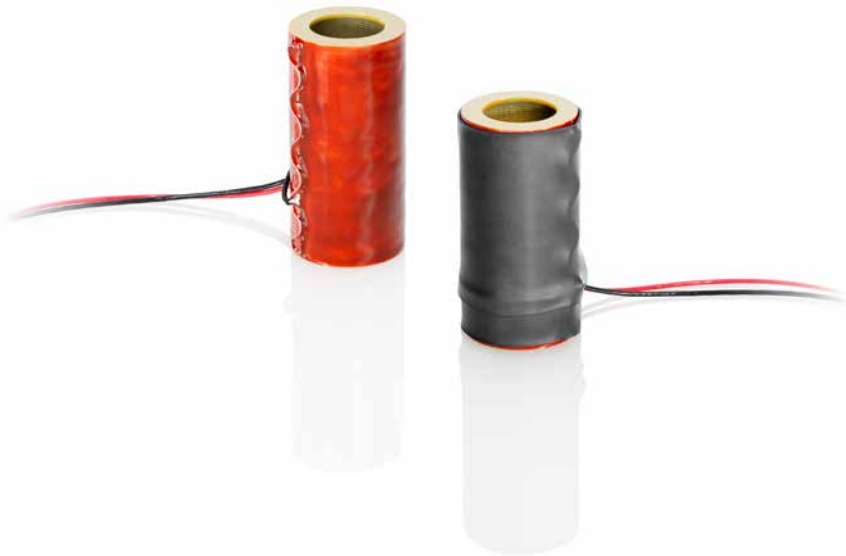

P-010.xxH – P-025.xxH

- High load capacity
- Extreme reliability: $>10^9$ cycles
- Microsecond response
- Sub-nanometer resolution
- Large choice of designs

Stacked Piezo Linear Actuator

Operating voltage 0 to 1000 V. Long lifetime without performance loss. High specific displacement. A mechanical preload can be attached via inner holes

Available Options

- SGS sensors for positional stability
- PZT ceramic material
- Operating voltage range, displacement, layer thickness
- Load capacity, force generation
- Geometric shapes: Round, rectangular, various cross sections
- Mechanical interfaces: Flat, spherical, metal, ceramic, glass, sapphire, etc.
- Integrated piezoelectric detector layers
- Special high / low temperature versions
- UHV-compatible to 10^{-9} hPa
- Non-magnetic versions
- Extra-tight length tolerances

Fields of Application

Research and industry. For optics, precision mechanics/machining, laser tuning



PICA Thru are manufactured in various sizes. Standard versions are delivered with stranded wires and are covered in black. Custom designs are available on request

Suitable Drivers

E-464 PICA Piezo Driver
E-481 PICA High-performance Piezo Driver / Controller
E-462 PICA Piezo Driver

Order Numbers	Displacement [μm] (0–1000 V) -10/+20%	Diameter OD [mm]	Diameter ID [mm]	Length L [mm] ± 0.5	Blocking force [N] (0–1000 V)	Stiffness [N/ μm]	Capacitance [nF] $\pm 20\%$	Resonant frequency [kHz]
P-010.00H	5	10	5	7	1200	230	15	144
P-010.10H	15	10	5	15	1700	110	40	67
P-010.20H	30	10	5	27	1800	59	82	39
P-010.40H	60	10	5	54	1800	29	180	21
P-016.00H	5	16	8	7	2900	580	42	144
P-016.10H	15	16	8	15	4100	270	120	67
P-016.20H	30	16	8	27	4500	150	230	39
P-016.40H	60	16	8	52	4700	78	490	21
P-025.10H	15	25	16	16	7400	490	220	63
P-025.20H	30	25	16	27	8700	290	430	39
P-025.40H	60	25	16	51	9000	150	920	22
P-025.50H	80	25	16	66	9600	120	1200	17

Piezo ceramic type: PIC151
 Standard electrical interfaces: FEP-insulated wire leads, 100 mm, AWG 24 (\varnothing 1.15 mm).
 Recommended preload for dynamic operation: 15 MPa.

Maximum preload for constant force: 30 MPa.
 Resonant frequency at $1 V_{pp}$, unloaded, free on both sides. The value is halved for unilateral clamping.
 Capacitance at $1 V_{pp}$, 1 kHz, RT.

Operating voltage: 0 to 1000 V.
 Operating temperature range: -20 to 85°C.
 Standard mechanical interfaces: Ceramic rings (passive PZT).

Outer surfaces: Polyolefin shrink sleeving, black (outside); epoxy resin (inside).
 Custom designs or different specifications on request.

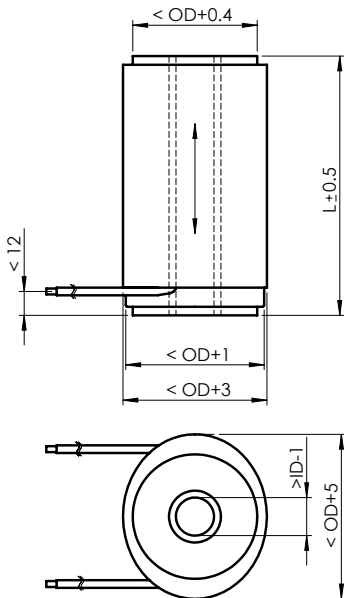

PICA Thru, dimensions in mm

PICA Shear Actuators

COMPACT MULTI-AXIS ACTUATORS

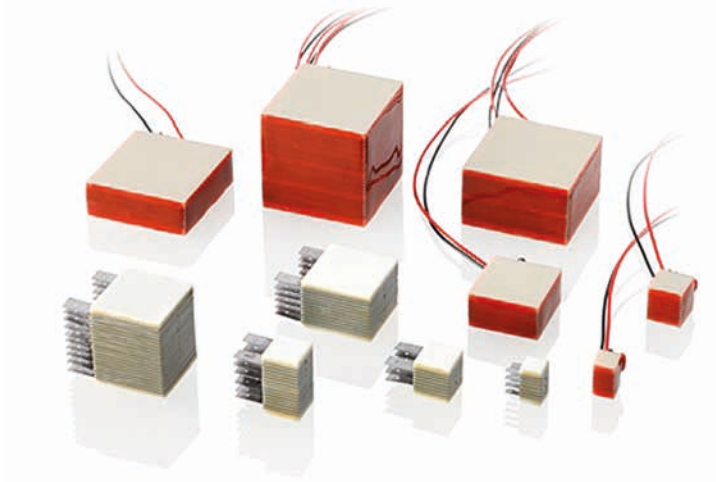

P-111 – P-151

- X, XY, XZ and XYZ versions
- Displacement to 10 μm
- Extreme reliability: $>10^9$ cycles
- Picometer resolution
- Microsecond response
- Large choice of designs

Piezo Shear Actuators

Operating voltage -250 to 250 V. Lateral motion is based on the piezoelectric shear effect. Excellent dynamics with minimum electric power requirement. Versions with inner holes or for use in cryogenic and UHV environments up to 10^{-9} hPa

Available Options

- PZT ceramic material
- Non-magnetic versions
- Operating voltage range, displacement, layer thickness, cross-sectional dimension
- Load capacity, force generation
- Mechanical interfaces: Flat, spherical, metal, ceramic, glass, sapphire, etc.
- Extra-tight length tolerances

Fields of Application

Research and industry, low-temperature/vacuum versions to 10^{-9} hPa. For scanning applications, microscopy, precision mechanics, switches

Suitable Drivers

E-413 DuraAct and PICA Shear Piezo Amplifier
E-508 PICA Piezo Driver Module

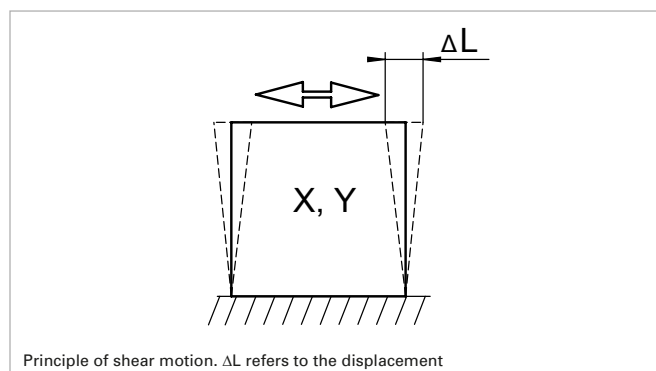
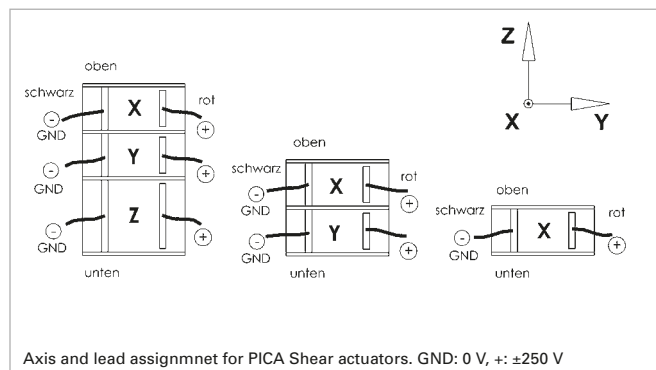

Order number	Active axes	Displacement [μm] (-250 to +250 V) -10/+20%	Cross section A x B / ID [mm]	Length L [mm] ± 0.3	Max. shear load [N]	Axial stiffness [N/ μm]	Capacitance [nF] $\pm 20\%$	Axial resonant frequency [kHz]
P-111.01	X	1*	3 x 3	3.5	20	70	0.5	330
P-111.03	X	3*	3 x 3	5.5	20	45	1.5	210
P-111.05	X	5	3 x 3	7.5	20	30	2.5	155
P-121.01	X	1*	5 x 5	3.5	50	190	1.4	330
P-121.03	X	3*	5 x 5	5.5	50	120	4.2	210
P-121.05	X	5	5 x 5	7.5	40	90	7	155
P-141.03	X	3*	10 x 10	5.5	200	490	17	210
P-141.05	X	5	10 x 10	7.5	200	360	28	155
P-141.10	X	10	10 x 10	12	200	230	50	100
P-151.03	X	3*	16 x 16	5.5	300	1300	43	210
P-151.05	X	5	16 x 16	7.5	300	920	71	155
P-151.10	X	10	16 x 16	12	300	580	130	100
P-112.01	XY	1 x 1*	3 x 3	5	20	50	0.5 / 0.5	230
P-112.03	XY	3 x 3*	3 x 3	9.5	10	25	1.5 / 1.5	120
P-122.01	XY	1 x 1*	5 x 5	5	50	140	1.4 / 1.4	230
P-122.03	XY	3 x 3*	5 x 5	9.5	40	70	4.2 / 4.2	120
P-122.05	XY	5 x 5	5 x 5	14	30	50	7 / 7	85
P-142.03	XY	3 x 3*	10 x 10	9.5	200	280	17 / 17	120
P-142.05	XY	5 x 5	10 x 10	14	100	190	28 / 28	85
P-142.10	XY	10 x 10	10 x 10	23	50	120	50 / 50	50
P-152.03	XY	3 x 3*	16 x 16	9.5	300	730	43 / 43	120
P-152.05	XY	5 x 5	16 x 16	14	300	490	71 / 71	85
P-152.10	XY	10 x 10	16 x 16	23	100	300	130 / 130	50
P-123.01	XYZ	1 x 1 x 1*	5 x 5	7.5	40	90	1.4 / 1.4 / 2.9	155
P-123.03	XYZ	3 x 3 x 3*	5 x 5	15.5	10	45	4.2 / 4.2 / 7.3	75
P-143.01	XYZ	1 x 1 x 1*	10 x 10	7.5	200	360	5.6 / 5.6 / 11	155
P-143.03	XYZ	3 x 3 x 3*	10 x 10	15.5	100	170	17 / 17 / 29	75
P-143.05	XYZ	5 x 5 x 5	10 x 10	23	50	120	28 / 28 / 47	50
P-153.03	XYZ	3 x 3 x 3*	16 x 16	15.5	300	450	43 / 43 / 73	75
P-153.05	XYZ	5 x 5 x 5	16 x 16	23	100	300	71 / 71 / 120	50
P-153.10	XYZ	10 x 10 x 10	16 x 16	40	60	170	130 / 130 / 230	30
Versions with inner hole								
P-153.10H	XYZ	10 x 10 x 10	16 x 16 / 10	40	20	120	89 / 89 / 160	30
P-151.03H	X	3*	16 x 16 / 10	5.5	200	870	30	210
P-151.05H	X	5	16 x 16 / 10	7.5	200	640	49	155
P-151.10H	X	10	16 x 16 / 10	12	200	400	89	100
Versions for use in cryogenic and UHV environments								
P-111.01T	X	1*	3 x 3	2.2	20	110	2 x 0.25	530
P-111.03T	X	3*	3 x 3	4.4	20	55	6 x 0.25	260
P-121.01T	X	1*	5 x 5	2.2	50	310	2 x 0.70	530
P-121.03T	X	3*	5 x 5	4.4	50	150	6 x 0.70	260

* Tolerances $\pm 30\%$.

Piezo ceramic type: PIC255

Standard electrical interfaces: PTFE-insulated wire leads, 100 mm, AWG 32 ($\varnothing 0.49$ mm).

Axial resonant frequency at $1 V_{pp}$, unloaded, unclamped. The value is halved for

unilateral clamping.

Capacitance at $1 V_{pp}$, 1 kHz, RT.

Operating voltage: -250 to 250 V.

Operating temperature range: -20 to 85°C.

Standard mechanical interfaces:

Ceramics (passive PZT).

Outer surface: Epoxy resin.

Versions for cryogenic and UHV environments

Operating temperature range: -269 to 85°C.

Temporary short-term bakeout to 150°C only when short-circuited.

Standard electrical interfaces: Ta. contacting possible with conductive adhesive or welding. Displacement measured at

room temperature. Reduced values at low temperatures.

Standard mechanical interfaces: Ceramic (Al_2O_3 , 96% purity).

Outer surface: Epoxy resin.

Custom designs or different specifications on request.

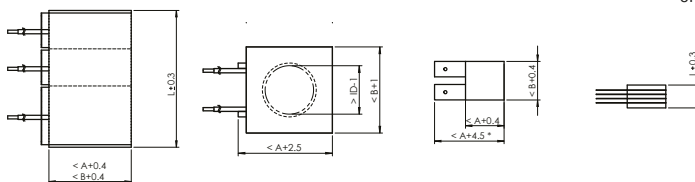

PICA Shear Actuators, A, B, L see table, dimensions in mm. The number of axes and wires depends on the type.

Left: P-1xx.xx and P-1xx.xxH (with inner hole), right: P-1xx.xxT, * $<A+2.5$ with a cross section of 3×3

Picoactuator®

MULTI-AXIS ACTUATORS WITH HIGHLY LINEAR DISPLACEMENT

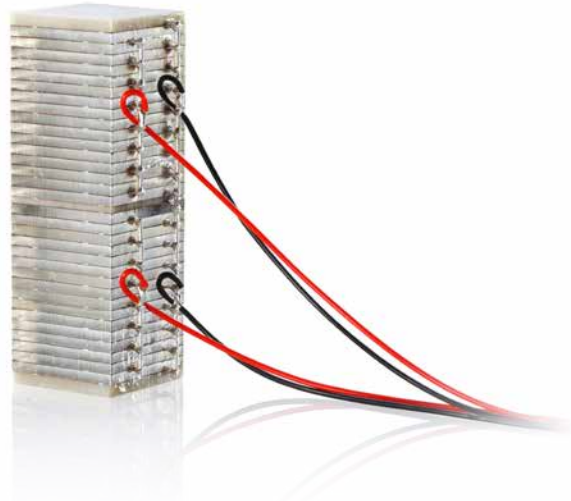

P-405

- Lead-free, crystalline actuator material
- High dynamics
- Ideal for operation without position control
- Low electrical power consumption
- Minimal length tolerances

Stack Actuator

Bipolar operating voltage up to ± 500 V. Nearly hysteresis-free motion ($< 0.2\%$). No creep. Picoactuators®, as longitudinal and shear actuators, are configurable up to heights of 20 mm and maximum travel of ± 3 μm

Available Options

- UHV-compatible to 10^{-9} hPa
- Inner hole
- End pieces

Fields of Application

Research and industry. Vacuum. For high-dynamics, open-loop scanning applications, compensation of undesired transverse motions with nanopositioning systems („out-of-plane“ and „out-of-line“)

Order number	Active axes	Dimensions A x B x L [mm]	Max. displacement * (-500 to +500 V) [μm]	Axial stiffness [N/ μm]	Max. shear load [N]	Electrical capacitance [nF] $\pm 10\%$	Axial resonant frequency [kHz]
Longitudinal actuators							
P-405.05	Z	5 x 5 x 12.5	1	140	10	0.95	160
P-405.08	Z	10 x 10 x 12.5	1	550	100	3.75	160
Shear actuators							
P-405.15	X	5 x 5 x 7.5	1	230	20	0.7	–
P-405.18	X	10 x 10 x 7.5	1	900	150	2.75	–
XZ actuators							
P-405.28	XZ	10 x 10 x 19	1 / 1	350	50	2.75 / 3.75	105

* Tolerances $\pm 20\%$.
Piezo material PIC 050.
Standard electrical interfaces: PTFE-insulated wire leads, 100 mm, AWG 32 ($\varnothing 0.76$ mm).
Axial resonant frequency measured at $1 V_{pp}$, unloaded, unclamped. The value is halved for unilateral clamping.
Capacitance at $1 V_{pp}$, 1 kHz, RT.
Operating voltage: -500 to 500 V.
Operating temperature range: -20 to 85°C.
Standard mechanical interfaces: Ceramics.
Outer surfaces: Epoxy resin.
Ask about custom designs!

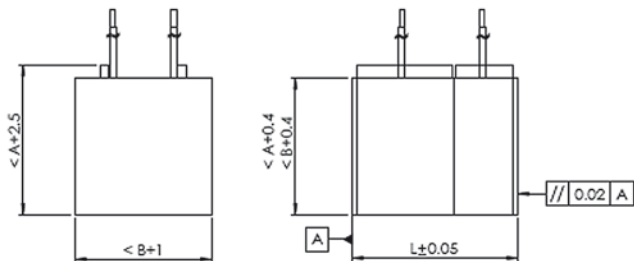

P-405, dimensions in mm. A, B, L see table

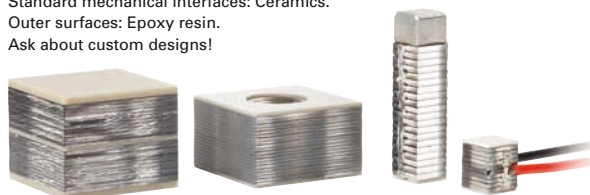

Picoactuators® can be produced in different configurations

Integrated Components

FROM THE CERAMIC TO THE COMPLETE SOLUTION

Ceramics in Different Levels of Integration

PIC integrates piezo ceramics into the customer's product. This includes both the electrical contacting of the elements according to customer requirements and the mounting of components provided by the customer, and the gluing or the casting of the piezo ceramics. For the customer, this means an accelerated manufacturing process and shorter lead times.

Sensor Components – Transducers

PI Ceramic supplies complete sound transducers in large batches for a wide variety of application fields. These include OEM assemblies for ultrasonic flow measurement technology, level, force and acceleration measurement.

Assembled Piezo Actuators

Piezo actuators can be equipped with sensors to measure the displacement and are then suitable for repeatable positioning with nanometer accuracy. Piezo actuators are often integrated into a mechanical system where lever amplification increases the travel. Flexure guiding systems then provide high stiffness and minimize the lateral offset.

Preloaded Actuators – Levers – Nanopositioning

PICMA® piezo actuators from PI Ceramic are the key component for nanopositioning systems from Physik Instrumente (PI). They are supplied in different levels of integration: As simple actuators with position sensor as an optional extra, encased with or without preload, with lever amplification for increased travel, right through to high-performance nanopositioning systems where piezo actuators drive up to six axes by means of zero-wear and frictionless flexure guides.

What they all have in common is motion resolution in the nanometer range, long lifetimes and outstanding reliability. The combination of PICMA® actuators, flexure guiding and precision measurement systems produces nanopositioning devices in the highest performance class.

Piezomotors

Piezo ceramics are the drive element for piezomotors from Physik Instrumente (PI), which make it possible to use the special characteristics of the piezo actuators over longer travel ranges as well. PILine® piezo ultrasonic motors allow very dynamic placement motions and can be manufactured with such a compact form that they are already being used in many new applications. Piezo stepping drives provide the high forces which piezo actuators generate over several millimeters. The patented NEXLINE® and NEXACT® drives from PI with their complex construction from longitudinal, shear and bender elements and the necessary contacting are manufactured completely at PI Ceramic.

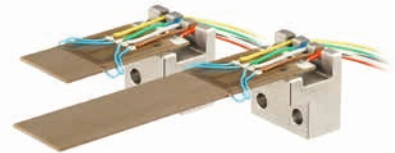

PICMA® piezo bending actuators with applied SGS sensors for measuring the displacement



Lever amplified system

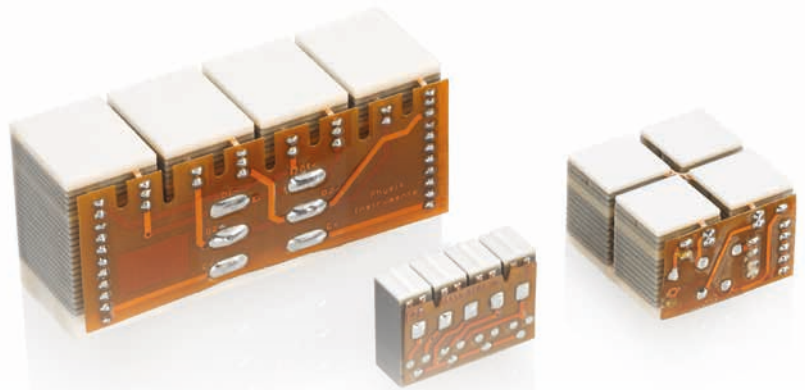

Actuator modules for NEXLINE® and NEXACT® piezo stepping motors

Piezo Drivers, Amplifiers & Controllers



Piezo amplifiers and controllers as miniature OEM modules and bench-top device

Piezo Electronics for Stability and Dynamics of Piezo Actuators

The drive electronics plays a key role in the performance of piezoelectric actuators. Piezo electronics are offered in flexible designs: as OEM board for integration, as "Plug&Play" bench-top device or in modular design for controlling almost any number of motion axes.

High-Power Amplifiers for High-Speed Switching Operations

For fields of application that require high dynamics, users can choose from a series of suitable solutions. For high-speed, low-frequency switching operations, amplifiers with high charge current are available. This results in fast displacement of the piezo actuator and fast step-and-settle at the target position. Overtemperature protection for electronics and piezo is available.

Dynamic Piezo Amplifiers for Scanners and Shutters

Switching amplifiers, designed for continuous operation and exhibiting much lower power consumption than linear amplifiers, allow high-frequency operation. Linear amplifiers are used for dynamic scanning operations. If linear displacement behavior is crucial, charge-controlled amplifiers are available, which compensate the deviation from linearity of the piezo actuators.

Low-Noise Voltage Amplifiers for Stable Displacement

Due to their high resolution of motion and dynamics, piezo actuators are capable of adjusting to minimal changes in voltage.

This is why for stable displacement particularly low-noise amplifiers are required.

Piezo controllers offer repeatable positioning in a closed servo loop: Since the displacement of piezo actuators is subject to drift and is non-linear, an additional position sensor and suitable control are required for reaching a position repeatably and stably holding it. Piezo controllers equipped with a closed servo loop are available as an OEM module, as a bench-top device or as a modular device.

Applications Outside Piezo Actuator Technology: Sensor Electronics and Energy Harvesting

In addition to amplifiers for actuator control, electronics for energy harvesting are also available. Sensor applications are highly specialized, making it necessary to adapt the electronics to each individual case. Thus, for example, OEM customers requesting solutions for applications in "Structural Health Monitoring" (SHM) or excitation of ultrasonic transducers benefit from optimized solutions.



The Energy Harvesting Evaluation Kit contains DuraAct piezo transducers plus the required transducer and storage electronics and cabling

Model Overview

DRIVERS FOR PIEZO STACK ACTUATORS: CLASSIFICATIONS, MODEL EXAMPLES AND CUSTOMIZATION OPTIONS

Amplifier classification	Linear amplifier, voltage-control, high current, continuous operation	Linear amplifier, voltage-control, high current	High-power piezo amplifier with energy recovery, class D (switching amp)	Linear amplifier, voltage-control	Linear amplifier, charge-control
Model examples For PICMA® Stacks	E-618	E-505.10	E-617 E-504	E-505.00 E-503 E-610 E-663 E-831 E-836 E-464 E-462	E-506.10
For PICA Stacks	–	E-421, E-470 E-508	E-481 E-482	–	–
Amplifier bandwidth, small signal	++	++	+	+	+
Relative rise time	++	+	O	O	O
Ripple / noise, 0 to 100 kHz	O	+	O	++	++
Linearity	+	+	+	+	++
Power consumption	O	+	++	+	+
Adequate for ...					
Precision positioning	O	O	O	++	--
High-dynamics scanning w/ high linearity	O	O	O	O	++
Fast switching, low cycles, low currents	+	++	++	O	+
Dynamic scanning, continuous operation	+	+	++	+	+
Dynamic scanning, high loads, high currents, continuous operation	++	+	+	+	+

O average; + good; ++ best

Customization of Drive Electronics

In addition to universal drive electronics that are highly suitable for most fields of application, PI offers a wide range of piezo amplifiers geared towards particular purposes. This comprises:

- The complete product range from electronic components and complete devices as an OEM circuit board through to the modular encased system
- Production of small batches and large series
- Product development according to special product standards (national or market-specific standards such as the Medical Device Act, for example) and the corresponding certification
- Adaptation of the systems to special environmental conditions (vacuum, space, clean room)
- Copy-exactly agreements

OEM Shaker Electronics for Ultrasonic Transducers

The voltage range can be adjusted to the required stroke.

- Small dimensions: 35 mm x 65 mm x 50 mm
- Bandwidth up to 20 kHz
- 24/7 Operation

Driving Micropumps

Piezo elements are ideal drives for miniaturized pumping and dosing system.

- Compact OEM electronics
- Suitable for installation on circuit boards (lab-on-a-chip)
- Frequency and amplitude control

Piezo Amplifier with High Bandwidth

- For low actuator capacitances, typ. up to a few 100 nF
- Max. output voltage range -100 to +350 V
- Max. continuous output power 15 W
- Bandwidth to 150 kHz

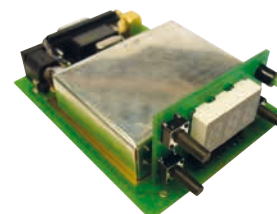
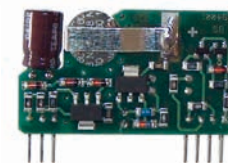

Piezo Drivers for PICMA® Piezo Actuators

OUTPUT VOLTAGE RANGE -30 TO 130 V



E-610 Single-Channel Controller

- Cost-effective single-channel OEM solution
- Open-loop versions or closed-loop versions for SGS & capacitive sensors
- Notch filter for higher bandwidth
- 180 mA peak current

E-500 Plug-in Modules

The E-500 modular piezo controller system features low-noise amplifiers in a 9.5- or 19-inch-rack.

- E-505: 2 A peak current
- E-505.10: 10 A peak current, peak output power of up to 1000 W
- E-503: 3 channels, peak current 3×140 mA
- E-506.10: Highly Linear Amplifier Module with Charge Control, 280 W peak output power



E-831 Miniature Modules

- Open-loop control
- Separate power supply for up to three electronics with up to -30 / +130V output voltage
- Bandwidth up to several kHz
- For capacities of up to 20 μ F
- For further miniaturization: extremely small OEM variants

E-836 OEM Module or Bench-Top Device

- Cost-effective, low-noise, for dynamic piezo actuator operation
- Peak current up to 100 mA
- 24 V operating voltage



E-617 Switching Amplifier with Energy Recovery

- Peak current of up to 2 A
- High average current up to 1 A
- Bandwidth of up to 3.5 kHz
- Low heat/power dissipation

E-618 High-Power Piezo Amplifier

- Peak current of up to 20 A
- Continuous current of up to 0.8 A
- Bandwidth of up to 15 kHz
- Integrated processing for temperature sensor
- Optionally with digital interfaces



Other Piezo Drivers

FOR PICA, BENDING AND SHEAR ACTUATORS, DURAECT TRANSDUCERS

Piezo Amplifier E-650 for Multilayer Bender Actuators

- Specifically designed to drive multilayer bimorph actuators without position sensor
- Output voltage range 0 to 60 V
- Two-channel tabletop* version or OEM version for soldering on a p.c.b.
- 300 mA peak current



Piezo Amplifier E-413 for DuraAct and PICA Shear

- Output voltage range up to -100 up to +400 V or $\pm 250V$
- 100 mA peak current
- OEM module / bench-top for PICA shear actuators
- OEM module for piezoelectrical DuraAct patch transducers

E-835 OEM Module: Bipolar Operation for Piezoelectric DuraAct Patch Transducers

- 120 mA peak current
- Output voltage range -100 to +250 V
- Compact: 87 mm x 50 mm x 21 mm
- High bandwidth of up to 4 kHz and more
- Sensor electronics on request

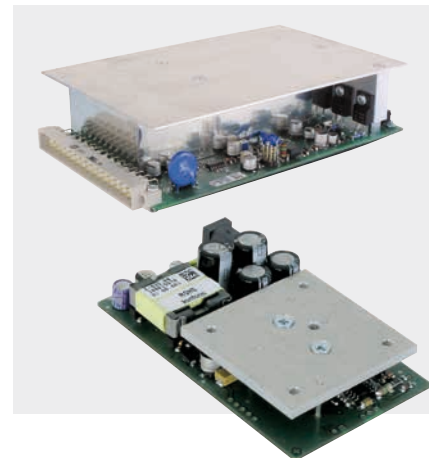

High-Power Piezo Amplifier / Controller

- E-481, E-482 Switching amplifier
- E-421, E-471 Modular design
- E-508 Driver module
- E-462 compact, for static applications
- Output voltage to 1100 V or bipolar
- Peak current up to 6 A
- Bandwidth to 5 kHz
- Overtemp protection
- Optional: position control, digital interfaces



Fundamentals of Piezo Technology

Basic Principles of Piezoelectricity	Page 39
Piezoelectric Effect – Ferroelectric Polarization – Expansion of the Polarized Piezo Ceramic	
Piezoelectric Actuator Materials	Page 40
Displacement Modes of Piezoelectric Actuators	Page 41
Manufacturing of Piezo Actuators	Page 46
Multilayer Tape Technology – Pressing Technology – Piezo Tube Actuators – DuraAct	
<hr/>	
Properties of Piezoelectric Actuators	Page 49
Displacement Behavior	Page 49
Nonlinearity – Hysteresis – Creep – Position Control	
Temperature-Dependent Behavior	Page 52
Forces and Stiffnesses	Page 54
Preload and Load Capacity – Stiffness – Force Generation and Displacement	
Dynamic Operation	Page 58
Resonant Frequency – How Fast Can a Piezo Actuator Expand – Dynamic Forces	
Electrical Operation	Page 59
Electrical Capacitance – Power Consumption – Continuous Operation – Pulse-Mode Operation	
Ambient Conditions	Page 62
Vacuum Environment – Inert Gases – Magnetic Fields – Gamma Radiation – Environments with High Humidity – Liquids	
Reliability of PICMA® Multilayer Actuators	Page 63
Lifetime when Exposed to DC Voltage – Lifetime in Dynamic Continuous Operation	
<hr/>	
Amplifiers: Piezo Electronics for Operating Piezo Actuators	Page 65
Characteristic Behavior of Piezo Amplifiers	Page 65
Power Requirements – Amplifier Frequency Response Curve – Setting the Control Input Voltage	
Solutions for High-Dynamics 24/7 Operation	Page 66
Switched Amplifiers with Energy Recovery – Overtemperature Protection – Charge Control	
<hr/>	
Handling of Piezo Actuators	Page 68
Mechanical Installation – Electrical Connection – Safe Operation	

Basic Principles of Piezoelectricity

The Piezoelectric Effect

Pressure generates charges on the surface of piezoelectric materials. This so-called direct piezoelectric effect, also called the generator or sensor effect, converts mechanical energy to electrical energy. The inverse piezoelectric effect in contrast causes this type of materials to change in length when an electrical voltage is applied. This effect converts electrical energy into mechanical energy and is thus employed in actuator technology.

The piezoelectric effect occurs in monocrystalline materials as well as in polycrystalline ferroelectric ceramics. In single crystals, an asymmetry in the structure of the unit cells of the crystal lattice, i.e. a polar axis that forms below the Curie temperature T_c , is a sufficient prerequisite for the effect to occur.

Piezoelectric ceramics also have a spontaneous polarization, i.e. the positive and negative charge concentration of the unit cells are separate from each other. At the same time, the axis of the unit cell extends in the direction of the spontaneous polarization and a spontaneous strain occurs (fig. 1).

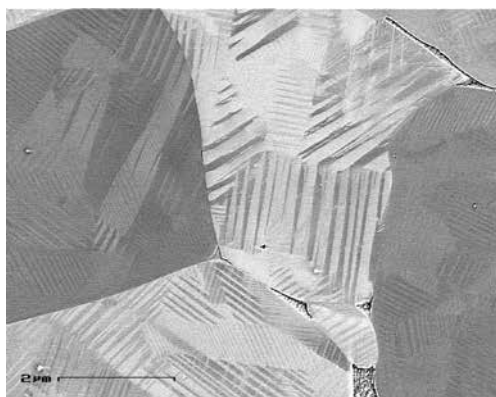

Fig. 2: A cross-sectional view of a ferroelectric ceramic clearly shows the differently polarized domains within the individual crystallites

(Source: Fraunhofer Institute for Ceramic Technologies and Systems IKTS, Dresden, Germany)

Ferroelectric Polarization

To minimize the internal energy of the material, ferroelectric domains form in the crystallites of the ceramic (fig. 2). Within these volume areas, the orientations of the spontaneous polarization are the same. The different orientations of bordering domains are separated by domain walls. A ferroelectric polarization process is required to make the ceramic macroscopically piezoelectric as well.

For this purpose, a strong electric field of several kV/mm is applied to create an asymmetry in the previously unorganized ceramic compound. The electric field causes a reorientation of the spontaneous polarization. At the same time, domains with a favorable orientation to the polarity field direction grow and those with an unfavorable orientation shrink. The domain walls are shifted in the crystal lattice. After polarization, most of the reorientations are preserved even without the application of an electric field (see fig. 3). However, a small number of the domain walls are shifted back to their original position, e.g. due to internal mechanical stresses.

Expansion of the Polarized Piezo Ceramic

The ceramic expands, whenever an electric field is applied, which is less strong than the original polarization field. Part of this effect is due to the piezoelectric shift of the ions in the crystal lattice and is called the intrinsic effect.

The extrinsic effect is based on a reversible ferroelectric reorientation of the unit cells. It increases along with the strength of the driving field and is responsible for most of the nonlinear hysteresis and drift characteristics of ferroelectric piezoceramics.

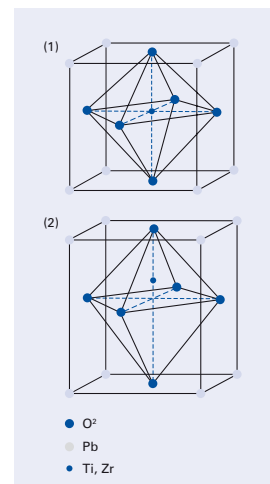

Fig. 1
(1) Unit cell with symmetrical, cubic structure above the Curie temperature T_c
(2) Tetragonally distorted unit cell below the Curie temperature T_c with spontaneous polarization and spontaneous strain

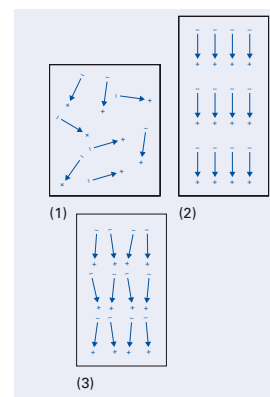

Fig. 3
Orientation of the spontaneous polarization within a piezo ferroelectric ceramic
(1) Unpolarized ceramic, (2) Ceramic during polarization and (3) ceramic after polarization

Piezoelectric Actuator Materials

BASIC PRINCIPLES OF PIEZOELECTRICITY

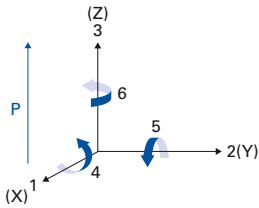

Fig. 4
Orthogonal system to describe the properties of a polarized piezo ceramic. Axis 3 is the direction of polarization

Commercially available piezoceramic materials are mostly based on the lead-zirconate-lead-titanate material system (PZT). By adding other materials the properties of the PZT compositions can be influenced.

Ferroelectrically soft piezoceramics with low polarity reversal field strengths are used for actuator applications since the extrinsic domain contributions lead to high overall piezo moduli. This includes the piezoceramics PIC151, PIC153, PIC255, PIC252 and PIC050.

Ferroelectrically hard PZT materials, such as PIC181 and PIC300, are primarily used in high-power ultrasound applications. They have a higher polarity reversal resistance, high mechanical quality factors as well as low hysteresis values at reduced piezoelectric deformation coefficients. The Picoactuator® series is based on the monocrystalline material PIC050, which has a highly linear, hysteresis-free characteristic, but with small piezoelectric coefficients.

Actuator Materials from PI Ceramic

PIC151 Modified PZT ceramic with balanced actuator characteristics. High piezoelectric coupling, average permittivity, relatively high Curie temperature.

Standard material for the PICA Stack, PICAThru and piezo tube product lines.

PIC153 Modified PZT ceramic for large displacements.

High piezoelectric deformation coefficients, high permittivity, relatively low Curie temperature.

Special material for the PICA Stack and PICA Thru product lines as well as for glued bending actuators.

PIC255 Modified PZT ceramic that is especially suited to bipolar operation, in shear actuators, or with high ambient temperatures.

High polarity reversal field strength (>1 kV/mm), high Curie temperature. Standard material for the PICA Power, PICA Shear, piezo tube and DuraAct product lines

PIC252 Variant of the PIC255 material with a lower sintering temperature for use in the multilayer tape process.

Standard material for the PICMA® Stack, PICMA® Chip and PICMA® Bender product lines as well as some DuraAct products.

PIC050 Crystalline material for linear, hysteresis-free positioning with small displacements in an open servo loop.

Excellent stability, high Curie temperature.

Standard material for the Picoactuator® product line.

	PIC151	PIC153	PIC255/252	PIC050
Physical and Dielectric Properties				
Density ρ [g/cm ³]	7.80	7.60	7.80	4.70
Curie temperature T_c [°C]	250	185	350	>500
Relative permittivity in polarization direction $\epsilon_{33}^T/\epsilon_0$	2400	4200	1750	60
perpendicular to polarization ϵ_{11}/ϵ_0	1980		1650	85
Dielectric loss factor $\tan \delta$ [10 ⁻³]	20	30	20	<1
Electro-Mechanical Properties				
Piezoelectric deformation coefficient, piezo modulus*				
d_{31} [pm/V]	- 210		- 180	
d_{33} [pm/V]	500	600	400	40
d_{15} [pm/V]			550	80
Acousto-Mechanical Properties				
Elastic compliance coefficient s_{11}^E [10 ⁻¹² m ² /N]	15.0			16.1
s_{33}^E [10 ⁻¹² m ² /N]	19.0			20.7
Mechanical quality factor Q_m		100	50	80

For explanations and further data, see the catalog "Piezoceramic Materials and Components"
*The deformation coefficient corresponds to the charge coefficient used with piezo components. The value depends on the strength of the driving field (fig. 22, p. 50). The information in the table refers to very small field strengths (small signal)

PI Ceramic offers a wide range of further materials, including lead-free piezoceramics that are currently mainly used as ultrasonic transducers.

For application-specific properties, actuators can be manufactured from special materials, although the technical implementation has to be individually checked. www.piceramic.com

Displacement Modes of Piezoelectric Actuators

BASIC PRINCIPLES OF PIEZOELECTRICITY

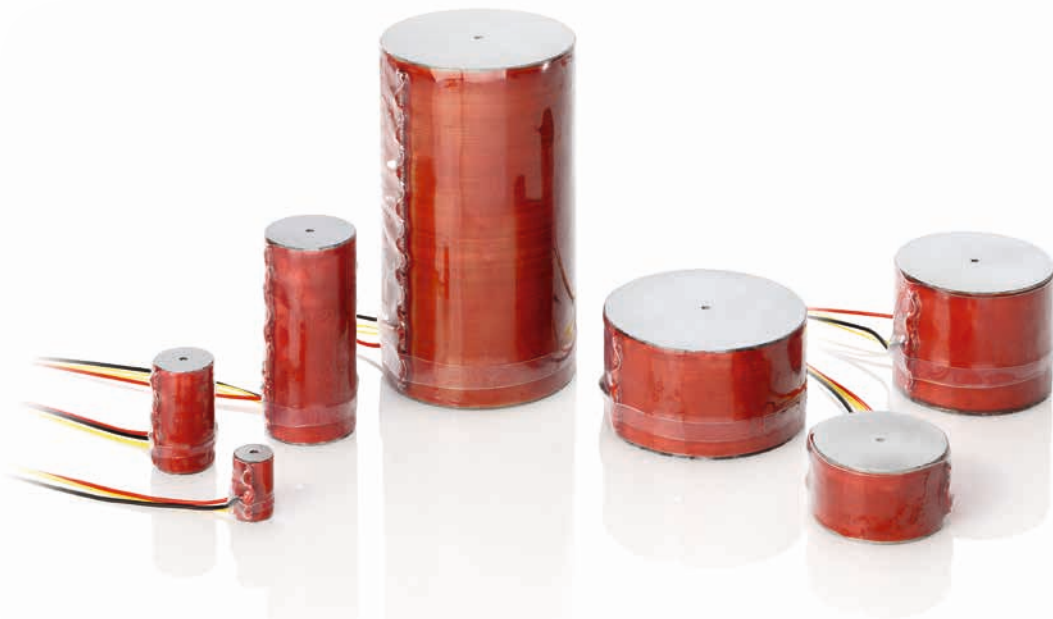

Examples of longitudinal stack actuators are the multilayer piezo actuators PICMA® Stack, Encapsulated PICMA®, PICMA® Chip, as well as the stacked actuators PICA Stack, PICA Power, PICA Thru that are glued together from individual plates, and the crystalline Picoactuator®.

Longitudinal Stack Actuators

In longitudinal piezo actuators, the electric field in the ceramic layer is applied parallel to the direction of polarization. This induces an expansion or displacement in the direction of polarization. Individual layers provide relatively low displacements. In order to achieve technically useful displacement values, stack actuators are constructed, where many individual layers are mechanically connected in series and electrically connected in parallel (fig. 5).

Longitudinal stack actuators are highly efficient in converting electrical to mechanical energy. They achieve nominal displacements of around 0.1 to 0.15% of the actuator length. The nominal blocking forces are on the order of

30 N/mm² in relation to the cross-sectional area of the actuator. Values of up to several 10000 Newton can thus be achieved in the actuator.

Longitudinal stack actuators are excellently suited for highly dynamic operation due to their high resonant frequencies. A mechanical preloading of the actuator suppresses dynamically induced tensile forces in brittle ceramic material, allowing response times in the microsecond range and a high mechanical performance.

ΔL_{long}	Longitudinal displacement [m]
$d_{33(GS)}$	Longitudinal piezoelectric large-signal deformation coefficient [m/V]
n	Number of stacked ceramic layers
V	Operating voltage [V]

In addition to the expansion in the direction of polarization, which is utilized with longitudinal actuators, a contraction always occurs in the piezo actuator that is orthogonal to its polarization when it is operated with an electric field parallel to the direction of polarization.

This so-called transversal piezoelectric effect is used by contracting actuators, tube actuators, or bending actuators.

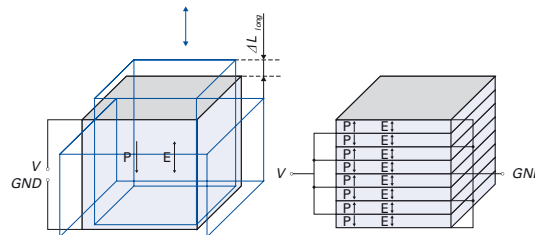

Fig. 5
 $\Delta L_{long} = n d_{33(GS)} V$ (Equation 1)

A typical application for shear actuators are drive elements for so-called stick-slip motors.

Shear actuators from PI Ceramic are offered as product lines PICA Shear und Picoactuator®.



Shear Actuators

In piezoelectric shear actuators, the electric field in the ceramic layer is applied orthogonally to the direction of polarization and the displacement in the direction of polarization is utilized. The displacements of the individual layers add up in stacked actuators here as well (fig. 6).

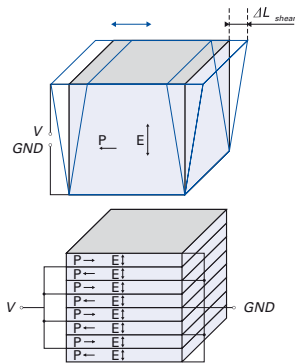

Fig. 6

$$\Delta L_{shear} = n d_{15(GS)} V$$

(Equation 2)

The shear deformation coefficients d_{15} are normally the largest piezoelectric coefficients. When controlled with nominal voltages, PIC ceramics achieve $d_{15(GS)}$ values of up to 2000 pm/V. The permissible controlling field strength is limited in order to prevent a reversal of the vertically oriented polarization.

When lateral forces act on the actuator, the shear motion is additionally superimposed by a bending. The same effect occurs in dynamic operation near the resonant frequency.

Furthermore, shear stresses cannot be compensated by a mechanical preload. Both, limit the practical stacking height of shear stacks.

Shear actuators combined with longitudinal actuators yield very compact XYZ stacks with high resonant frequencies.

Picoactuator® Technology

Picoactuator® longitudinal and shear actuators are made of the crystalline piezoelectric material PIC 050. The specific displacement is $\pm 0.02\%$ (shear actuators) or $\pm 0.01\%$ (longitudinal piezo actuators) of the actuator length and is thus 10 times lower than for classic piezo actuators made of lead zirconate - lead titanate (PZT). The displacement here is highly linear with a deviation of only 0.2%.

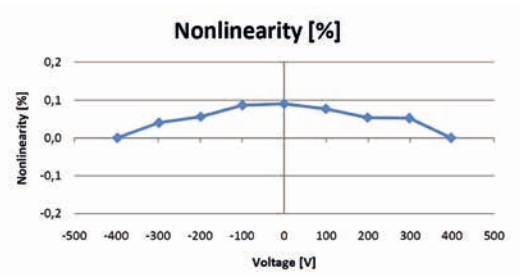

Fig. 7 Measured nonlinearity of a Picoactuator®



Tube Actuators

Tube actuators are radially polarized. The electrodes are applied on the outer surfaces, so that the field parallel to the polarization also runs in a radial direction. Tube actuators use the transversal piezoelectric effect to generate displacements. Axial displacements or changes in length (fig. 8), lateral motions such as changes in the radius (fig. 9), as well as bending (fig. 10) are possible.

In order to cause a tube to bend, the outer electrode is segmented into several sections. When the respectively opposite electrodes are driven, the tube bends in a lateral direction.

Undesirable tilting or axial motions that occur during this process can be prevented by more complex electrode arrangements. For example, an eight-electrode arrangement creates a counter bending and overall achieves a lateral displacement without tilting.

PI Ceramic offers precision tube actuators in the piezo tube product line.



Axial displacement

$$\Delta L_{axial} = d_{31(GS)} \frac{l}{t} V$$

(Equation 3)

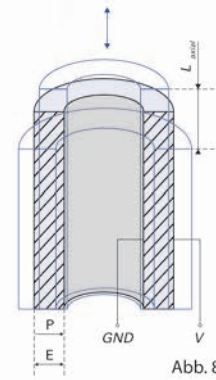

Fig. 8

Radial displacement (radius change)

The following estimation applies for large radii:

$$\Delta L_{radial} \approx d_{31(GS)} \frac{ID+t}{2t} V$$

(Equation 4)

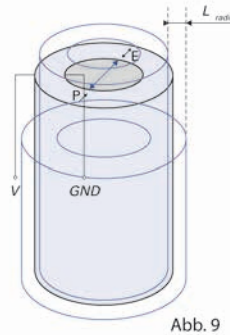

Fig. 9

Bending actuators, XY scanning tubes

$$\Delta L_{lateral} = 0.9 d_{31(GS)} \frac{l^2}{(ID+t)t} V$$

(Equation 5)

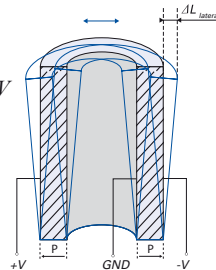

Fig. 10

ΔL_{shear}	Shear displacement [m]
$d_{15(GS)}$	Piezoelectric large-signal shear deformation coefficient [m/V]
n	Number of stacked ceramic layers
V	Operating voltage [V]
ΔL_{axial}	Axial tube displacement [m]
ΔL_{radial}	Radial tube displacement [m]
$\Delta L_{lateral}$	Lateral tube displacement [m]
$d_{31(GS)}$	Transversal piezoelectric large-signal deformation coefficient [m/V]
l	Tube length [m]
ID	Internal tube diameter [m]
t	Tube wall thickness (= (OD-ID)/2) [m]
For all equations, $ID \gg t$. All tube dimensions, see data sheet	

Tube actuators are often used in scanning probe microscopes to provide dynamic scanning motions in open-loop operation, and as fiber stretchers.

Further application examples are microdosing in the construction of nanoliter pumps or in inkjet printers.

ΔL_{trans}	Transversal displacement [m]
$d_{31(GS)}$	Transversal piezoelectric large-signal deformation coefficient [m/V]
l	Length of the piezo ceramic in the direction of displacement [m]
h	Height of a ceramic layer [m]
n	Number of stacked ceramic layers
V	Operating voltage [V]
ΔL_{bend}	Bending displacement [m]
l_f	Free bender length [m]
h_p	Height piezo-ceramic element [m]
R_h	Ratio of the heights of the substrate (h_s) and piezoceramic element (h_p) in a composite bender ($R_h = h_s/h_p$)
R_E	Ratio of the elasticity modulus of the substrate (E_s) and the piezo-ceramic element (E_p) in a composite bender ($R_E = E_s/E_p$)
V_F	Fixed voltage for bender actuator control [V] (V and V_F can be superimposed with an offset voltage)

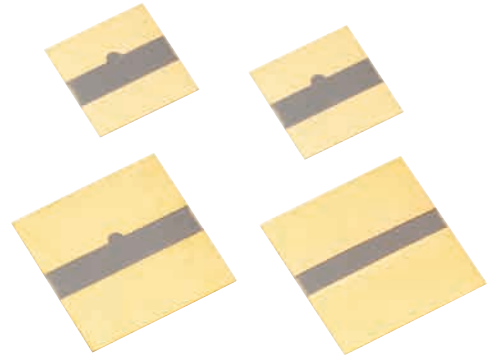
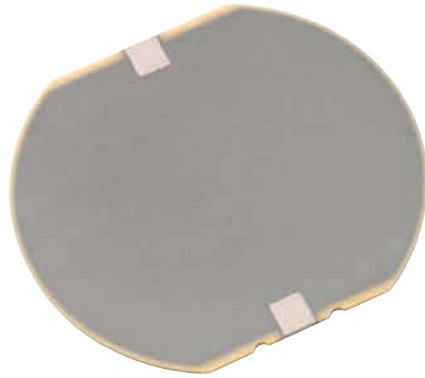
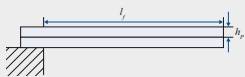

Contracting Actuators

Typically, piezo contracting actuators are low-profile components. Their displacement occurs perpendicularly to the polarization direction and to the electric field. The displacement of contracting actuators is based on the transversal piezoelectric effect whereby up to approx. 20 μm is nominally achieved.

Multilayer elements offer decisive advantages over single-layer piezo elements in regard to technical realization: Due to the larger cross-sectional area, they generate higher forces and can be operated with a lower voltage (fig. 11).

As a result of the contraction, tensile stresses occur that can cause damage to the brittle piezo ceramic. A preload is therefore recommended.

For the patch actuators of the DuraAct product group, a piezo contractor is laminated into a polymer. This creates a mechanical preload that protects the ceramic against breakage.

Multilayer contracting actuators can be requested as special versions of the PICMA® Bender product line.

Fig. 11

$$\Delta L_{trans} = d_{31(GS)} \frac{l}{h} V \quad (\text{Equation 6})$$

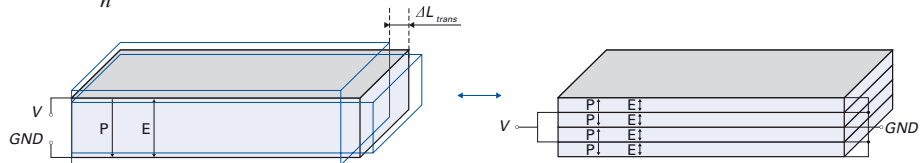

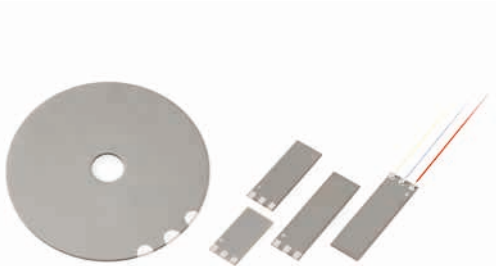

Bending Actuators

Attached to a substrate, contracting actuators act as bending actuators (fig. 12). For the construction of all-ceramic benders, two active piezoceramic elements are joined and electrically controlled. If a passive substrate made of metal or ceramic material, for example, is used, one speaks of composite benders. The piezoceramic elements can be designed as individual layers or as multilayer elements.

Piezoelectric bending actuators function according to the principle of thermostatic bimetals. When a flat piezo contracting actuator is coupled to a substrate, the driving and contraction of the ceramic creates a bending moment that converts the small transversal

change in length into a large bending displacement vertical to the contraction. Depending on the geometry, translation factors of 30 to 40 are attainable, although at the cost of the conversion efficiency and the force generation.

With piezoelectric bending actuators, displacements of up to several millimeters can be achieved with response times in the millisecond range. The blocking forces, however, are relatively low. They are typically in the range of millinewtons to a few newtons.

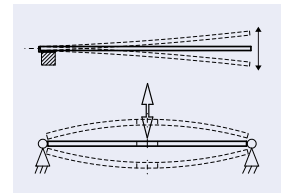

Fig. 17 By selecting a two-sided restraint with a rotatable mounting (bottom) instead of a single-sided fixed restraint (top), the ratio of the displacement and the force of the bender can be changed. The displacement is reduced by a factor of four while the blocking force is increased by a factor of four. Especially high forces can be attained when using flat bending plates or disks with a restraint on two sides instead of strip-shaped benders

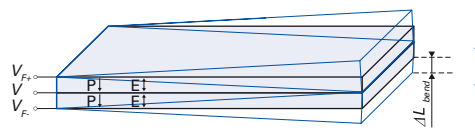

Fig. 12: Displacement of bending actuators

All-ceramic bending actuator for parallel circuiting

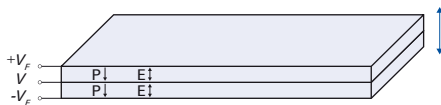

Fig. 13

$$\Delta L_{bend} = \frac{3}{8} n d \frac{l_f^2}{h_p^2} V \quad (\text{Equation 7})$$

All-ceramic bending actuator for serial circuiting

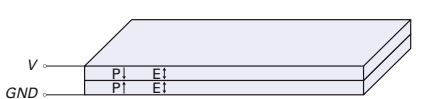

Fig. 14

$$\Delta L_{bend} = \frac{3}{8} n d_{31(GS)} \frac{l_f^2}{h_p^2} V \quad (\text{Equation 8})$$

(Operation against the polarization direction only possible with reduced voltage or field strength, p. 49 ff.)

Two-layer composite bender with one-sided displacement

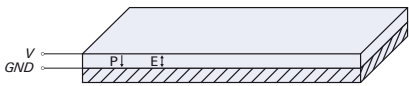

Fig. 15

$$\Delta L_{bend} = \frac{3}{8} n d_{31(GS)} \frac{l_f^2}{h_p^2} \frac{2R_h R_E (I + R_h)}{R_h R_E (I + R_h)^2 + 0.25(I - R_h^2 R_E)^2} V$$

(Equation 9)
Application DuraAct, PICMA® Bender (customized versions)

Symmetrical three-layer composite bender for parallel circuiting

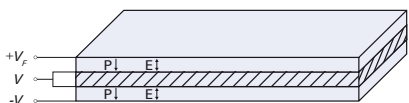

Fig. 16

$$\Delta L_{bend} = \frac{3}{8} n d_{31(GS)} \frac{l_f^2}{h_p^2} \frac{I + R_h}{I + 1.5R_h + 0.75R_h^2 + 0.125R_E R_h^3} V$$

(Equation 10)

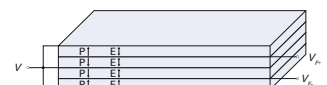

Fig. 18

The products of the PICMA® Bender line are all-ceramic bending actuators with two piezoceramic elements that each consist of several active layers (multilayer actuators)

Equations according to Pfeifer, G.: Piezoelektrische lineare Stellantriebe. Scientific journal series of Chemnitz University of Technology 6/1982

Manufacturing of Piezo Actuators

BASIC PRINCIPLES OF PIEZOELECTRICITY

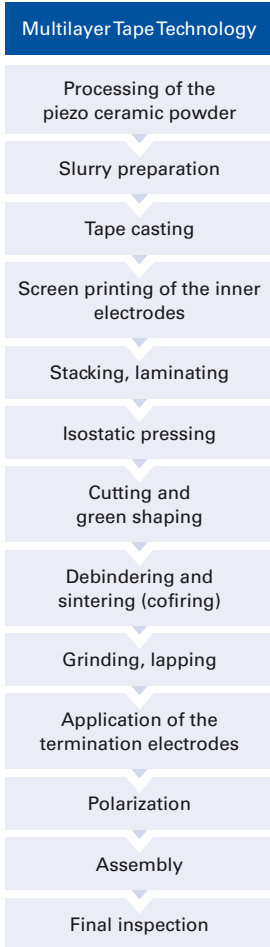

Multilayer Tape Technology

The technologies for manufacturing piezo actuators decisively contribute to their function, quality and efficiency. PI Ceramic is proficient in a wide range of technologies, from multilayer tape technology for PICMA® stack and bending actuators, through glued stack actuators for longitudinal and shear displacements, up to the construction of crystalline Picoactuator® actuators, the DuraAct patch transducers and piezoceramic tubes.

PI Ceramic multilayer actuators, PICMA® for short, are manufactured in large batches with tape technology. First, the inner electrode pattern is printed on thin PZT tapes while still unsintered and these are then laminated into a multilayer compound. In the subsequent cofiring process, the ceramic and the inner electrodes are sintered together. The finished monolithic multilayer piezo element has no polymer content anymore.

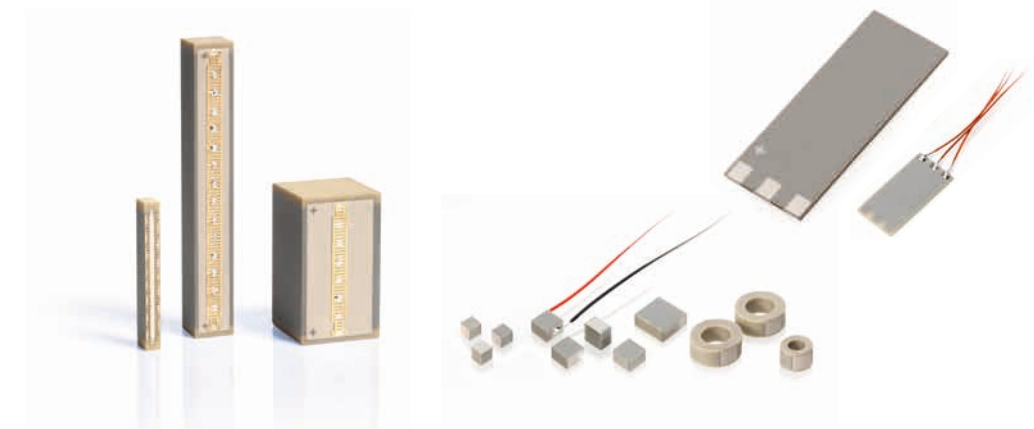
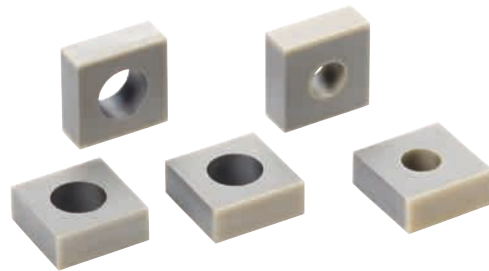

The inner electrodes of all PICMA® actuators are ceramically insulated (fig. 19). PICMA® Stack actuators use a patented structure for this purpose, in which a thin ceramic insulation tape covers the electrodes without significantly limiting the displacement.

The more fine-grained the ceramic material used, the thinner the multiple layers that can be produced. In PICMA® Stack actuators, the height of the active layers is 60 µm and in PICMA® Bender actuators around 20 to 30 µm, so that the benders can be operated with a very low nominal voltage of only 60 V.



Hermetically encapsulated PICMA® were developed for applications in extremely high humidity and in rough industrial environments. They are equipped with corrosion-resistant stainless-steel bellows, inert gas filling, glass feedthroughs and laser welding

In the past years, the technologies for processing actuators in an unsintered state have been continuously developed. For this reason, round geometries or PICMA® actuators with an inner hole can also be manufactured

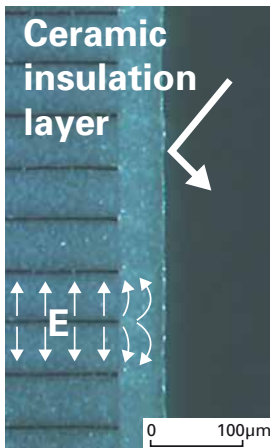

Fig. 19
In PICMA® stack actuators, a ceramic insulation tape covers the inner electrodes

PICMA® multilayer actuators are produced in different shapes. Depending on the application, they can also be assembled with adapted ceramic or metal end pieces, additional coating, temperature sensors, etc.

Pressing Technology

PICA stack actuators such as PICA Stack, Thru or Shear consist of thin piezoceramic plates with a standard layer thickness of 0.5 mm. For manufacturing, piezoceramic cylinders or blocks are shaped with pressing technology, sintered and then separated into plates with diamond wafer saws. Metal electrodes are attached with thin or thick film methods depending on the material, and the ceramic is then polarized.

Stack actuators are created by gluing the plates together whereby a thin metal contact plate is placed between each two ceramic plates in order to contact the attached electrodes. The contact plates are connected with each other in a soldering step, and the finished stack is then covered with a protective polymer layer and possibly an additional shrink tubing.

Picoactuator® piezo actuators consist of crystalline layers with a thickness of 0.38 mm. In contrast to ceramic, the orientation of the spontaneous polarization is not determined by a ferroelectric polarization but by the cutting direction in the monocrystal. All other processing and mounting steps are similar to those for stacked PICA actuators.

Completely assembled stack actuators with a metal endpiece and SGS expansion sensor (left), with stranded wires, temperature sensor and transparent FEP shrink tubing (right)



Pressing Technology

Processing of the piezo ceramic powder

Mixing the raw materials

Calcination, presintering

Milling

Spray drying

Pressing and shaping

Debinding and sintering

Lapping, grinding, diamond slicing

Application of electrodes by screen printing or sputtering

Polarization

Mounting and assembling technology: Gluing, poss. ultrasonic drilling for inner hole, soldering, coating

Final inspection

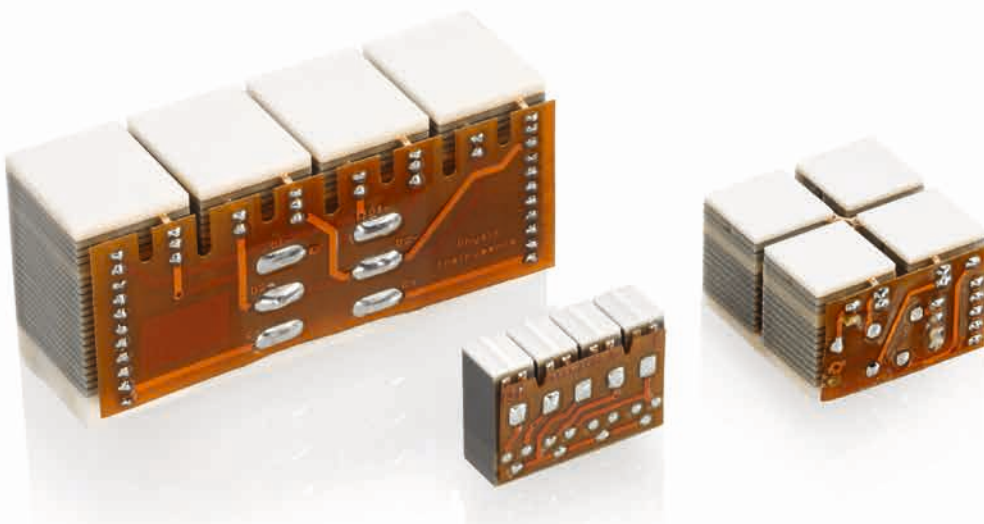

The final processing of the piezoceramic plates manufactured with pressing technology is adapted to their future use. The figure shows different piezo actuator modules



Structured electrodes allow specific driving of tube actuators

Piezo Tube Actuators

Piezo tube actuators are manufactured from piezoceramic cylinders that were previously produced with the pressing technology. The outer diameter and the parallelism of the end-surface are precisely set through centerless circular grinding and surface grinding. The inner hole is drilled with an ultrasonic method.

The metalization then is done with thin- or thick-layer electrodes, possibly accompanied by structuring of the electrodes with a laser ablation method.

In addition to the described procedure for manufacturing precision tubes with very narrow geometric tolerances, the more cost-efficient extrusion method is also available for small diameters.

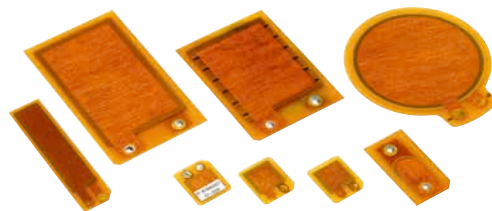

Different shapes of DuraAct actuators with ceramic plates in pressing and multilayer technology

DuraAct Patch Actuators and Transducers

DuraAct patch actuators use piezoceramic contracting plates as their base product. Depending on the piezoceramic thickness, these plates are manufactured with pressing technology (>0.2 mm) or tape technology (0.05 to 0.2 mm). The plates are connected to form a composite using conductive fabric layers, positioning tapes, and polyimide cover tapes.

The lamination process is done in an autoclave in a vacuum, using an injection method. This results in completely bubble-free laminates of the highest quality.

The curing temperature profile of the autoclave is selected so that a defined internal preload of the piezoceramic plates will result due to the different thermal expansion coefficients of the materials involved.

The result of this patented technology are robust, bendable transducer elements that can be manufactured in large batches.



Laminated ceramic layers in a DuraAct transducer arrangement (array)

Properties of Piezoelectric Actuators

DISPLACEMENT BEHAVIOR

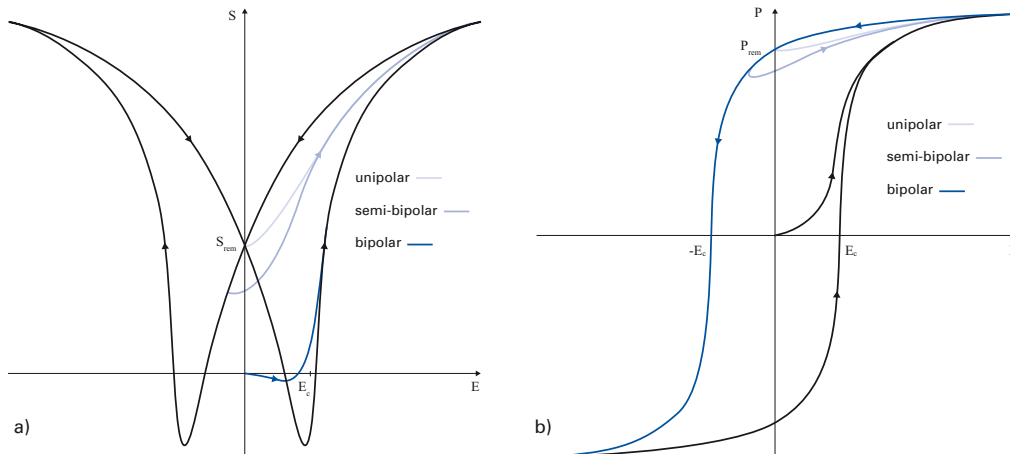

Fig. 20: Displacement of ferroelectric piezo ceramics with different control amplitudes parallel to the direction of polarization direction. Large-signal curves as a function of the electrical field strength E a) electromechanical behavior of the longitudinal strain S, b) dielectric behavior of the polarization P

Nonlinearity

The voltage-dependent displacement curves of piezo actuators have a strongly nonlinear course that is subject to hysteresis due to the extrinsic domain contributions. It is therefore

not possible to interpolate linearly from the nominal displacement to intermediate positions with a particular driving voltage. The electromechanical and dielectric large-signal curves of piezo ceramics illustrate the characteristics (fig. 20). The origin of each graph is defined by the respective thermally depolarized condition.

The shape of both bipolar large-signal curves is determined by the ferroelectric polarity reversal process when the coercive field strength E_c is achieved in the opposing field. The dielectric curve shows the very large polarization changes at these switchover points. At the same time, the contraction of the ceramic after reversing the polarity turns into an expansion again, since the polarization and the field strength have the same orientation once more. This property gives the electromechanical curve its characteristic butterfly shape. Without the electric field, the remnant polarizations $P_{rem} / -P_{rem}$ and the remnant strain S_{rem} remain.

Piezo actuators are usually driven unipolarly. A semi-bipolar operation increases the strain amplitude while causing a stronger nonlinearity and hysteresis which result from the increasing extrinsic domain portions of the displacement signal (fig. 21).

In the PI and PI Ceramic data sheets, the free displacements of the actuators are given at nominal voltage.

Piezoelectric Deformation Coefficient (Piezo Modulus)

The gradient $\Delta S / \Delta E$ between the two switchover points of the nonlinear hysteresis curves is defined as the piezoelectric large-signal deformation coefficients $d_{(GS)}$ (fig. 21). As the progressive course of the curves shows, these coefficients normally increase along with the field amplitude (fig. 22).

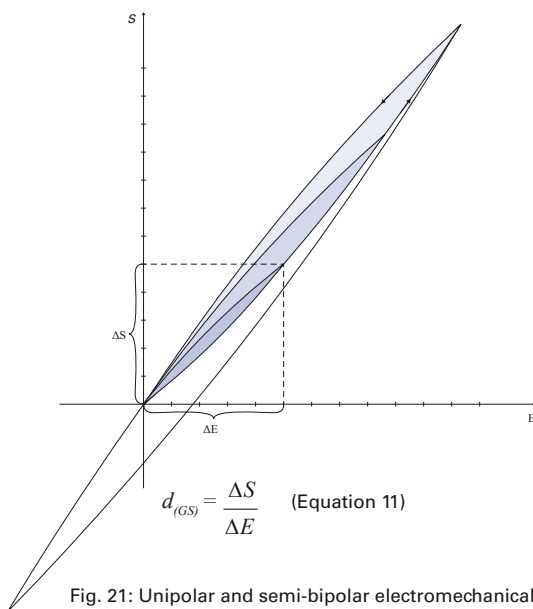

Fig. 21: Unipolar and semi-bipolar electromechanical curves of ferroelectric piezo ceramics and definition of the piezoelectric large-signal deformation coefficient $d_{(GS)}$ as the slope between the switchover points of a partial hysteresis curve

$$d_{(GS)} = \frac{\Delta S}{\Delta E} \quad (\text{Equation 11})$$

Estimation of the Expected Displacement

If the values from fig. 22 are entered into the equations 3 to 10 (p. 43–45), the attainable displacement at a particular piezo voltage can be estimated. The field strength can be calculated from the layer heights of the specific component and the drive voltage V_{pp} . The layer thickness of the PI Ceramic standard products can be found starting on p. 46.

The free displacement of the components that can actually be attained depends on further factors such as the mechanical preload, the temperature, the control frequency, the dimensions, and the amount of passive material.

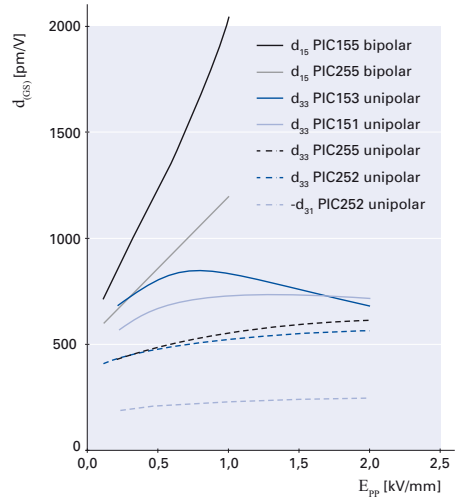

Fig. 22: Piezoelectric large-signal deformation coefficients $d_{(GS)}$ for different materials and control modes at room temperature and with quasistatic control. With very small field amplitudes, the values of the coefficients match the material constants on p. 40

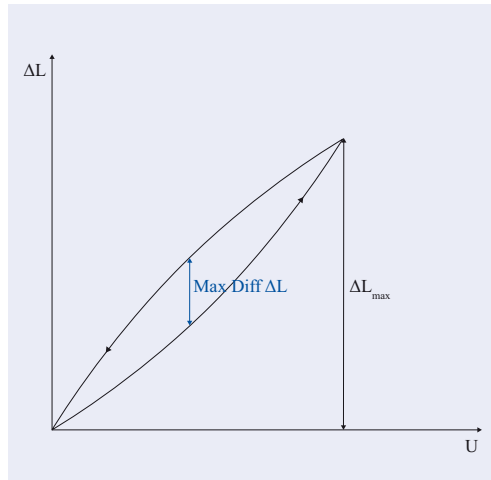

Fig. 23: The hysteresis value H_{disp} is defined as the ratio between the maximum opening of the curve and the maximum displacement

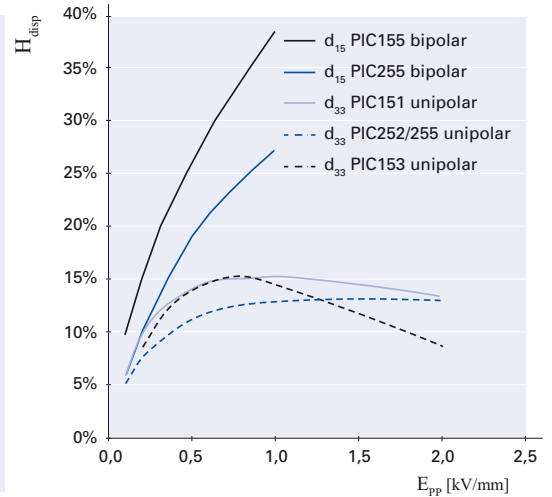

Fig. 24: Displacement hysteresis H_{disp} of various actuator materials in open-loop, voltage-controlled operation for different drive modes at room temperature and with quasistatic control

Hysteresis

In open-loop, voltage-controlled operation, the displacement curves of piezo actuators show a strong hysteresis (fig. 24) that usually rises with an increasing voltage or field strength.

Especially high values result for shear actuators or with bipolar control. The reason for these values is the increasing involvement of extrinsic polarity reversal processes in the overall signal.

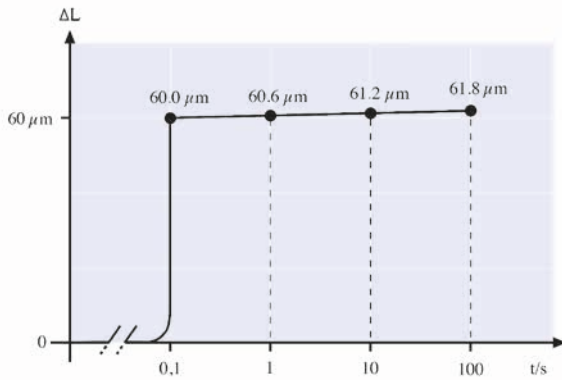

Fig. 25: Displacement of a piezo actuator when driven with a sudden voltage change (step function). The creep causes approx. 1% of the displacement change per logarithmic decade

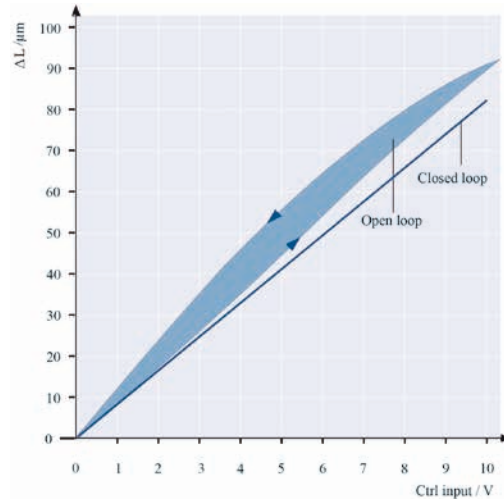

Fig. 26: Elimination of hysteresis and creep in a piezo actuator through position control

Creep

Creep describes the change in the displacement over time with an unchanged drive voltage. The creep speed decreases logarithmically over time. The same material properties that are responsible for the hysteresis also cause the creep behavior:

$$\Delta L(t) \approx \Delta L_{t=0.1s} \left[1 + \gamma \lg\left(\frac{t}{0.1s}\right) \right] \quad (\text{Equation 12})$$

t	Time [s]
$\Delta L(t)$	Displacement as a function of time [m]
$\Delta L_{t=0.1s}$	Displacement at 0.1 seconds after the end of the voltage change [m]
γ	Creep factor, depends on the material properties (approx. 0.01 to 0.02, corresponds to 1% to 2% per decade)

Position Control

Hysteresis and creep of piezo actuators can be eliminated the most effectively through position control in a closed servo loop. To build position-controlled systems, the PI Ceramic piezo actuators of the PICA Stack and PICA Power product line can be optionally offered with applied strain gauges.

In applications with a purely dynamic control, the hysteresis can be effectively reduced to values of 1 to 2% even with open-loop control by using a charge-control amplifier (p. 67).

Temperature-Dependent Behavior

PROPERTIES OF PIEZOELECTRIC ACTUATORS

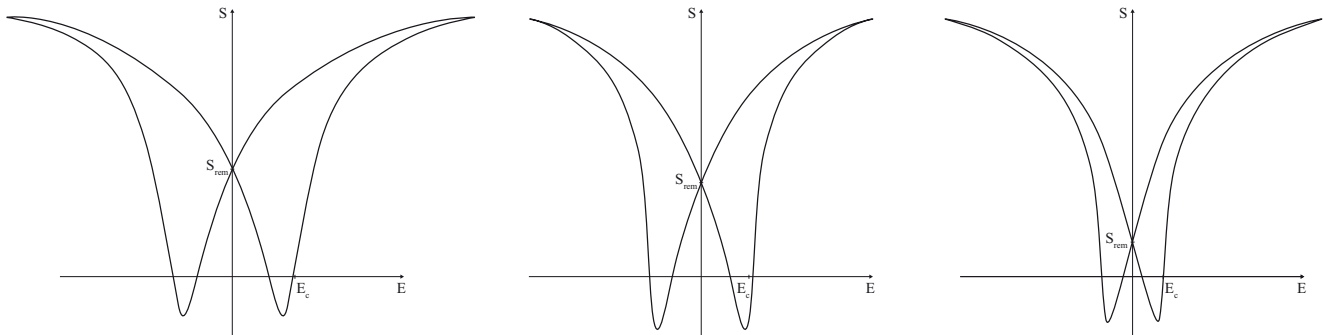

Fig. 27: Bipolar electromechanical large-signal curve of piezo actuators at different temperatures. From left: behavior at low temperatures, at room temperature, at high temperatures

Below the Curie temperature, the temperature dependence of the remnant strain and the coercive field strength is decisive for the temperature behavior. Both the attainable displacement with electric operation and the dimensions of the piezoceramic element change depending on the temperature.

The cooler the piezo actuator, the greater the remnant strain S_{rem} and the coercive field strength E_{rem} (fig. 27). The curves become increasingly flatter with decreasing temperatures. This causes the strain induced by a unipolar control to become smaller and smaller even though the total amplitude of the bipolar strain curve hardly changes over wide temperature ranges. The lower the temperature, the greater the remnant strain. All in all, the piezo ceramic has a negative thermal expansion coefficient, i.e., the piezo ceramic becomes longer when it cools down. In comparison: A technical ceramic contracts with a relatively low thermal expansion coefficient upon cooling. This surprising effect is stronger, the more completely the piezo ceramic is polarized.

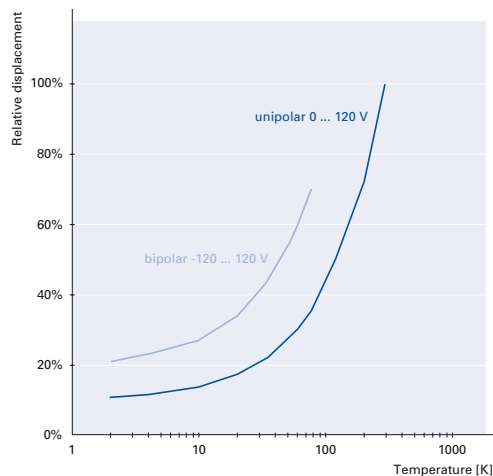

Fig. 28: Relative decrease in the displacement using the example of a PICMA® Stack actuator in the cryogenic temperature range with different piezo voltages in relation to nominal displacement at room temperature

Displacement as a Function of the Temperature

How much a key parameter of the piezo actuator changes with the temperature depends on the distance from the Curie temperature. PICMA® actuators have a relatively high Curie temperature of 350°C. At high operating temperatures, their displacement only changes by the factor of 0.05%/K.

At cryogenic temperatures, the displacement decreases. When driven unipolarly in the liquid-helium temperature range, piezo actuators only achieve 10 to 15% of the displacement at room temperature. Considerably higher displacements at lower temperatures can be achieved with a bipolar drive. Since the coercive field strength increases with cooling (fig. 27), it is possible to operate the actuator with higher voltages, even against its polarization direction.

Dimension as a Function of the Temperature

The temperature expansion coefficient of an all-ceramic PICMA® Stack actuator is approximately -2.5 ppm/K. In contrast, the additional metal contact plates as well as the adhesive layers in a PICA Stack actuator lead to a non-linear characteristic with a positive total coefficient (fig. 29).

If a nanopositioning system is operated in a closed servo loop, this will eliminate temperature drift in addition to the nonlinearity, hysteresis, and creep. The control reserve to be kept for this purpose, however, reduces the usable displacement.

For this reason, the temperature drift is often passively compensated for by a suitable selection of the involved materials, the actuator types, and the system design. For example, all-ceramic PICMA® Bender actuators show only a minimal temperature drift in the displacement direction due to their symmetrical structure.

Temperature Operating Range

The standard temperature operating range of glued actuators is -20 to 85°C. Selecting piezo ceramics with high Curie temperatures and suitable adhesives can increase this range. Most PICMA® multilayer products are specified for the extended range of -40 to 150°C. With special solders, the temperature range can be increased so that special models of PICMA® actuators can be used between -271°C and 200°C i.e. over a range of almost 500 K.

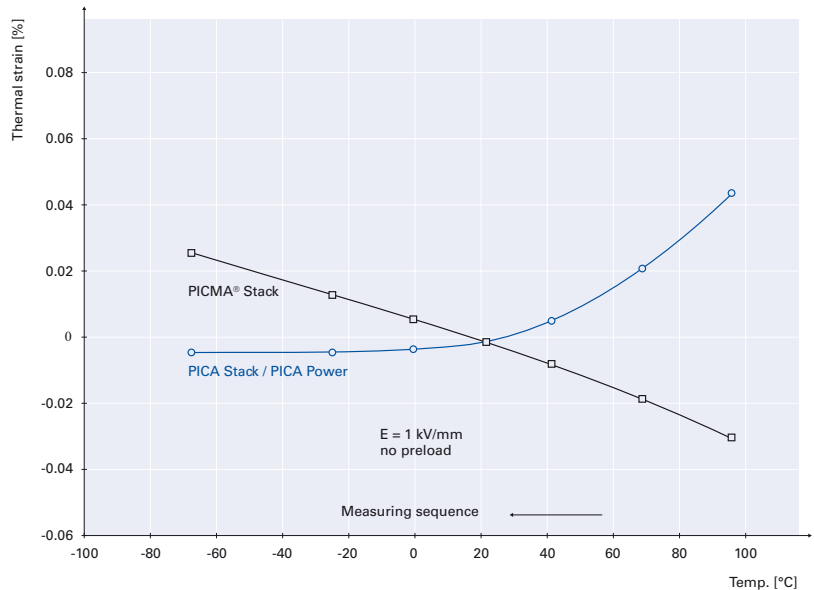

Fig. 29: Temperature expansion behavior of PICMA® and PICA actuators with electric large-signal control

Forces and Stiffnesses

PROPERTIES OF PIEZOELECTRIC ACTUATORS

E^*	Effective elasticity module: Linear increase of a stress-strain curve of a sample body or actuator made of the corresponding piezoceramic material (fig. 30)
A	Actuator cross-sectional area
l	Actuator length
k_A	Actuator stiffness
ΔL_0	Nominal displacement
F_{max}	Blocking force
k_L	Load stiffness
F_{eff}	Effective force

Preload and Load Capacity

The tensile strengths of brittle piezoceramic and single-crystal actuators are relatively low, with values in the range of 5 to 10 MPa. It is therefore recommended to mechanically preload the actuators in the installation. The preload should be selected as low as possible. According to experience, 15 MPa is sufficient to compensate for dynamic forces (p. 58); in the case of a constant load, 30 MPa should not be exceeded.

Lateral forces primarily cause shearing stresses in short actuators. In longer actuators with a larger aspect ratio, bending stresses are also generated. The sum of both loads yield the maximum lateral load capacities that are given for the PICA shear actuators in the data sheet. However, it is normally recommended to protect the actuators against lateral forces by using guidings.

Stiffness

The actuator stiffness k_A is an important parameter for calculating force generation, resonant frequency, and system behavior. Piezoceramic stack actuators are characterized by very high stiffness values of up to several hundred newtons per micrometer. The following equation is used for calculation:

$$k_{A\text{ Stack}} = \frac{E^* A}{l} \quad (\text{Equation 13})$$

Bending actuators, however, have stiffnesses of a few Newtons per millimeter, lower by several orders of magnitude. In addition to the geometry, the actuator stiffness also depends on the effective elasticity module E^* . Because of the mechanical depolarization processes, the shape of the stress-strain curves (fig. 30) is similarly nonlinear and subject to hysteresis as are the electromechanical curves (fig. 21). In addition, the shape of the curve depends on the respective electrical control conditions, the drive frequency, and the mechanical preload so that values in a range from 25 to 60 GPa can be measured. As a consequence, it is difficult to define a generally valid stiffness value.

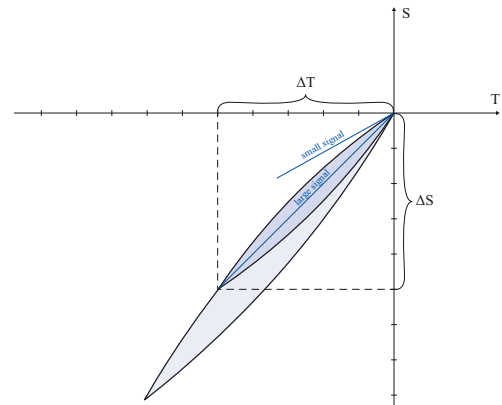

Fig. 30: Stress-strain curve of a piezoceramic stack actuator when driven with a high field strength, in order to prevent mechanical depolarizations. The linear increase $\Delta T/\Delta S$ defines the effective large-signal elasticity module $E^*_{(GS)}$. Small-signal values of the elasticity modules are always greater than large-signal values

Limitations of the Preload

The actuator begins to mechanically depolarize at only a few tens of MPa. A large-signal control repolarizes the actuator; on the one hand, this causes the induced displacement to increase but on the other hand, the effective capacity and loss values increase as well, which is detrimental to the lifetime of the component.

A pressure preload also partially generates tensile stress (p. 68). For this reason, when very high preloads are used, the tensile strength can locally be exceeded, resulting in a possible reduction of lifetime or damage to the actuator. The amount of the possible preload is not determined by the strength of the ceramic material. Piezo actuators attain compressive strengths of more than 250 MPa.

For specifying piezo actuators, the quasistatic large-signal stiffness is determined with simultaneous control with a high field strength or voltage and low mechanical preload. As a result, an unfavorable operating case is considered, i.e. the actual actuator stiffness in an application is often higher.

The adhesive layers in the PICA actuators only reduce the stiffness slightly. By using optimized technologies, the adhesive gaps are only a few micrometers high so that the large-signal stiffness is only approx. 10 to 20% lower than that of multilayer actuators without adhesive layers.

The actuator design has a much stronger influence on the total stiffness, e.g. spherical end piece with a relatively flexible point contact to the opposite face.

Force Generation and Displacement

The generation of force or displacement in the piezo actuator can best be understood from the working graph (fig. 32). Each curve is determined by two values, the nominal displacement and the blocking force.

Nominal Displacement

The nominal displacement ΔL_0 is specified in the technical data of an actuator. To determine this value, the actuator is operated freely, i.e. without a spring preload, so that no force has to be produced during displacement. After the corresponding voltage has been applied, the displacement is measured.

Blocking Force

The blocking force F_{max} is the maximum force produced by the actuator. This force is achieved when the displacement of the actuator is completely blocked, i.e. it works against a load with an infinitely high stiffness.

Since such a stiffness does not exist in reality, the blocking force is measured as follows: The actuator length before operation is recorded. The actuator is displaced without a load to the nominal displacement and then pushed back to the initial position with an increasing external force. The force required for this purpose amounts to the blocking force.

Typical Load Cases

The actuator stiffness k_A can be taken from the working graph (fig. 32):

$$k_A = \frac{F_{max}}{\Delta L_0} \quad (\text{Equation 14})$$

It corresponds to the inverted slope of the curve. The actuator makes it possible to attain any displacement/force point on and below the nominal voltage curve, with a corresponding load and drive.

Displacement without Preload, Load with Low Stiffness

If the piezo actuator works against a spring force, its induced displacement decreases because a counterforce builds up when the spring compresses. In most applications of piezo actuators, the effective stiffness of the load k_L is considerably lower than the stiffness k_A of the actuator. The resulting displacement ΔL is thus closer to the nominal displacement ΔL_0 :

$$\Delta L \approx \Delta L_0 \left(\frac{k_A}{k_A + k_L} \right) \quad (\text{Equation 15})$$

The displacement/force curve in fig. 31 on the right is called the working curve of the actuator/spring system. The slope of the working curve $F_{eff} / \Delta L$ corresponds to the load stiffness k_L .

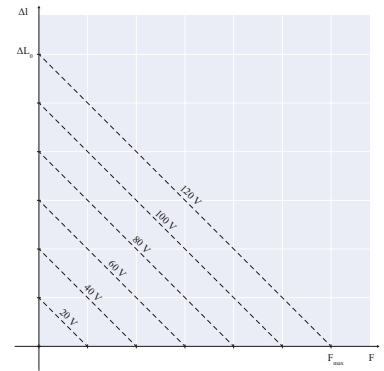

Fig. 32: Working graph of a PICMA® stack actuator with unipolar operation at different voltage levels

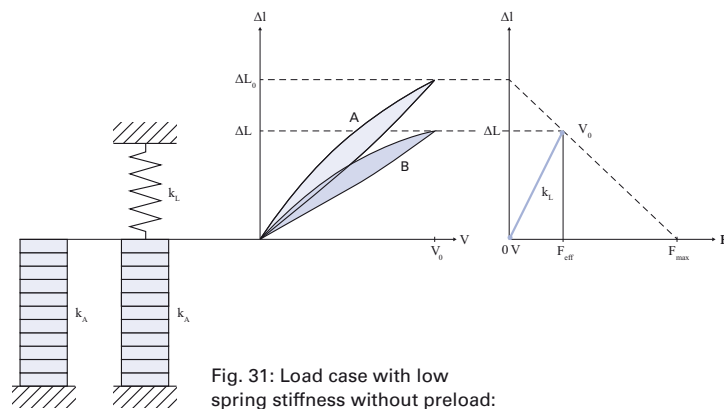

Fig. 31: Load case with low spring stiffness without preload: Drawing, displacement/voltage graph, working graph with working curve

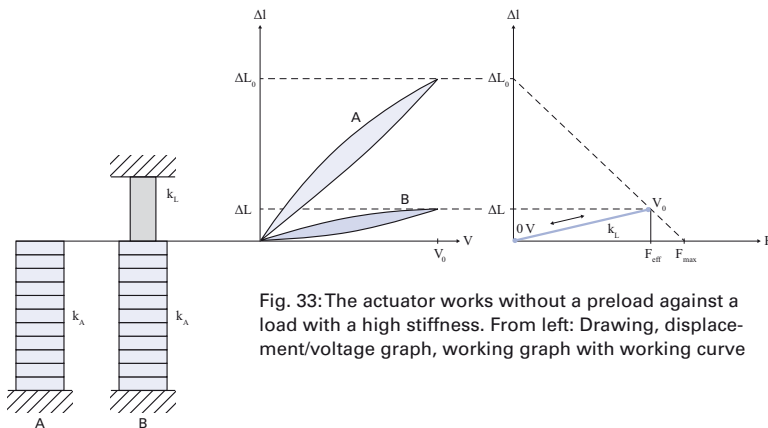

Fig. 33: The actuator works without a preload against a load with a high stiffness. From left: Drawing, displacement/voltage graph, working graph with working curve

Force Generation Without Preload, Load with High Stiffness

When large forces are to be generated, the load stiffness k_L must be greater than that of the actuator k_A (fig. 33):

$$F_{\text{eff}} \approx F_{\text{max}} \left(\frac{k_L}{k_A + k_L} \right) \quad (\text{Equation 16})$$

The careful introduction of force is especially important in this load case, since large mechanical loads arise in the actuator. In order to achieve long lifetime, it is imperative to avoid local pull forces (p. 54).

Nonlinear Load Without Preload, Opening and Closing of a Valve

As an example of a load case in which a nonlinear working curve arises, a valve control is sketched in fig. 34. The beginning of the displacement corresponds to operation without a load. A stronger opposing force acts near the valve closure as a result of the fluid flow. When the valve seat is reached, the displacement is almost completely blocked so that only the force increases.

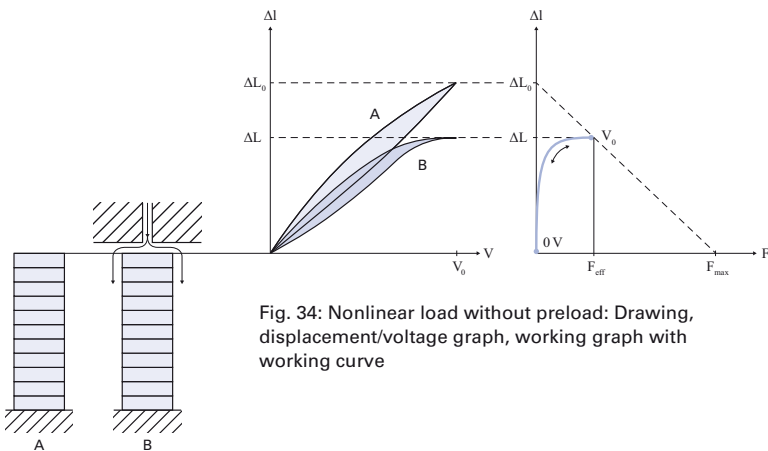

Fig. 34: Nonlinear load without preload: Drawing, displacement/voltage graph, working graph with working curve

Large Constant Load

If a mass is applied to the actuator, the weight force F_v causes a compression of the actuator.

The zero position at the beginning of the subsequent drive signal shifts along the stiffness curve of the actuator. No additional force occurs during the subsequent drive signal change so that the working curve approximately corresponds to the course without preload.

An example of such an application is damping the oscillations of a machine with a great mass.

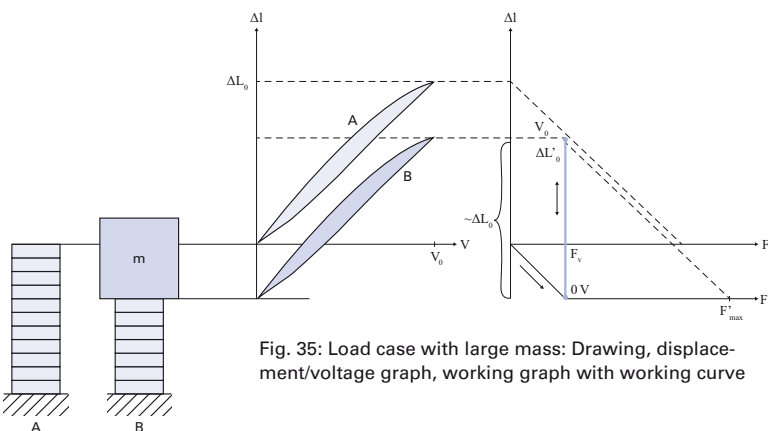

Fig. 35: Load case with large mass: Drawing, displacement/voltage graph, working graph with working curve

Example: The stiffness considerably increases when the actuator is electrically operated with a high impedance, as is the case with charge-control amplifiers (p. 67). When a mechanical load is applied, a charge is generated that cannot flow off due to the high impedance and therefore generates a strong opposing field which increases the stiffness.

Spring Preload

If the mechanical preload is applied by a relatively soft spring inside a case, the same shift takes place on the stiffness curve as when a mass is applied (fig. 36). With a control voltage applied, however, the actuator generates a small additional force and the displacement decreases somewhat in relation to the case without load due to the preload spring (Equation 15). The stiffness of the preload spring should therefore be at least one order of magnitude lower than that of the actuator.

Actuator Dimensioning and Energy Consideration

In the case of longitudinal stack actuators, the actuator length is the determining variable for the displacement ΔL_0 . In the case of nominal field strengths of 2 kV/mm, displacements of 0.10 to 0.15% of the length are achievable. The cross-sectional area determines the blocking force F_{max} . Approximately 30 N/mm² can be achieved here.

The actuator volume is thus the determining parameter for the attainable mechanical energy $E_{mech} = (\Delta L_0 F_{max})/2$.

The energy amount E_{mech} that is converted from electrical to mechanical energy when an actuator is operated, corresponds to the area underneath the curve in fig. 37. However, only a fraction E_{out} of this total amount can be transferred to the mechanical load. The mechanical system is energetically optimized when the area reaches its maximum. This case occurs when the load stiffness and the actuator

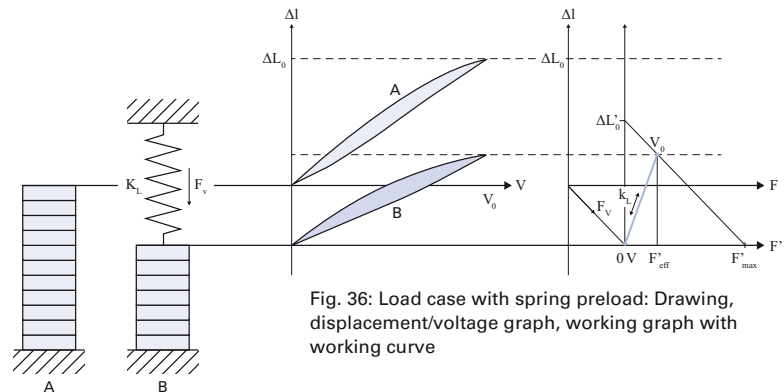

Fig. 36: Load case with spring preload: Drawing, displacement/voltage graph, working graph with working curve

stiffness are equal. The light blue area in the working graph corresponds to this amount. A longitudinal piezo actuator can perform approx. 2 to 5 mJ/cm³ of mechanical work and a bending actuator achieves around 10 times lower values.

Efficiency and Energy Balance of a Piezo Actuator System

The calculation and optimization of the total efficiency of a piezo actuator system depends on the efficiency of the amplifier electronics, the electromechanical conversion, the mechanical energy transfer, and the possible energy recovery. The majority of electrical and mechanical energies are basically reactive energies that can be recovered minus the losses, e.g. from heat generation. This makes it possible to construct very efficient piezo systems, especially for dynamic applications.

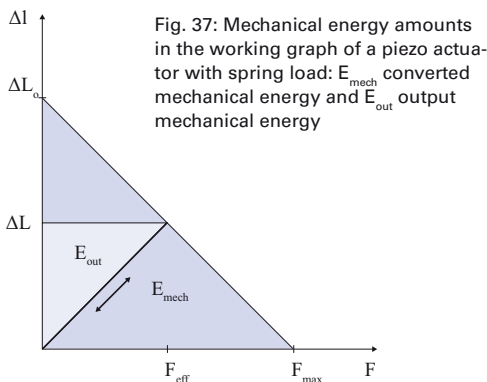

Fig. 37: Mechanical energy amounts in the working graph of a piezo actuator with spring load: E_{mech} converted mechanical energy and E_{out} output mechanical energy

Dynamic Operation

PROPERTIES OF PIEZOELECTRIC ACTUATORS

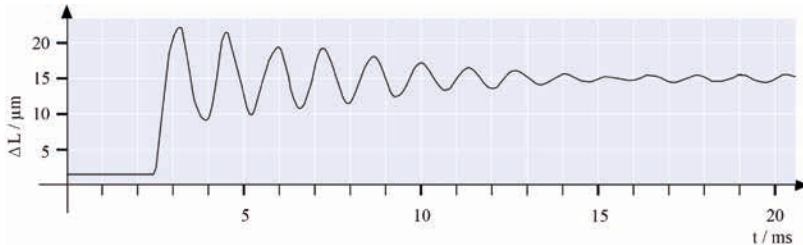

Fig. 38: Displacement of an undamped piezo system after a voltage jump. The nominal displacement is attained after around one third of the period length

This behavior is desired especially in dynamic applications, such as scanning microscopy, image stabilization, valve controls, generating shockwaves, or active vibration damping. When the control voltage suddenly increases, a piezo actuator can reach its nominal displacement in approximately one third of the period of its resonant frequency f_0 (fig. 38).

$$T_{min} \approx \frac{1}{3f_0} \quad (\text{Equation 19})$$

In this case, a strong overshoot occurs which can be partially compensated for with corresponding control technology.

Example: A unilaterally clamped piezo actuator with a resonant frequency of $f_0 = 10$ kHz can reach its nominal displacement in 30 μ s.

Dynamic Forces

With suitable drive electronics, piezo actuators can generate high accelerations of several ten thousand m/s^2 . As a result of the inertia of possible coupled masses as well as of the actuators themselves, dynamic pull forces occur that have to be compensated for with mechanical preloads (p. 54 ff).

In sinusoidal operation, the maximum forces can be estimated as follows:

$$F_{dyn} \approx \pm 4\pi^2 m_{eff}' \frac{\Delta L}{2} f^2 \quad (\text{Equation 20})$$

Example: The dynamic forces at 1000 Hz, 2 μ m displacement (peak-to-peak) and 1 kg mass are approximately ± 40 N.

m	Mass of the piezo actuator
M	Additional load
φ	Phase angle [degree]
f_0	Resonant frequency without load [Hz]
f_0'	Resonant frequency with load [Hz]
F_{dyn}	Dynamic force [N]
m_{eff}	Effective mass of the piezo stack actuator [kg]
m_{eff}'	Effective mass of the piezo stack actuator with load [kg]
ΔL	Displacement (peak-peak) [m]
f	Control frequency [Hz]

Resonant frequency

The resonant frequencies specified for longitudinal stack actuators apply to operation when not clamped on both sides. In an arrangement with unilateral clamping, the value has to be divided in half.

The reducing influence of an additional load on the resonant frequency can be estimated with the following equation:

$$f_0' = f_0 \sqrt{\frac{m_{eff}}{m_{eff}'}} \quad (\text{Equation 17})$$

In positioning applications, piezo actuators are operated considerably below the resonant frequency in order to keep the phase shift between the control signal and the displacement low. The phase response of a piezo system can be approximated by a second order system:

$$\varphi \approx 2 \arctan \left(\frac{f}{f_0} \right) \quad (\text{Equation 18})$$

How Fast Can a Piezo Actuator Expand?

Fast response behavior is a characteristic feature of piezo actuators. A fast change in the operating voltage causes a fast position change.

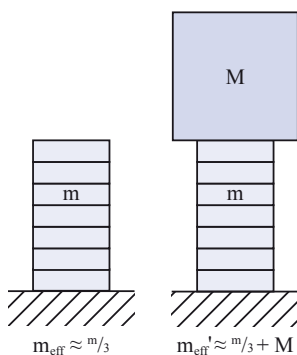

Fig. 39: Calculation of the effective masses m_{eff} and m_{eff}' of a unilaterally clamped piezo stack actuator without and with load

Electrical Operation

PROPERTIES OF PIEZOELECTRIC ACTUATORS

Operating Voltage

PI Ceramic offers various types of piezo actuators with different layer thicknesses. This results in nominal operating voltages from 60 V for PICMA® Bender actuators to up to 1000 V for actuators of the PICA series.

Electrical Behavior

At operating frequencies well below the resonant frequency, a piezo actuator behaves like a capacitor. The actuator displacement is proportional to the stored electrical charge, as a first order estimate.

The capacitance of the actuator depends on the area and thickness of the ceramic as well as the material properties. In the case of actuators that are constructed of several ceramic layers electrically connected in parallel, the capacitance also depends on the number of layers.

In the actuators there are leakage current losses in the μA range or below due to the high internal resistance.

Electrical Capacitance Values

The actuator capacitance values indicated in the technical data tables are small-signal values, i.e. measured at 1 V, 1000 Hz, 20°C, unloaded. The capacitance of piezoceramics changes with the voltage amplitude, the temperature and the mechanical load, to up to 200% of the unloaded, small-signal, room-temperature value. For calculations under

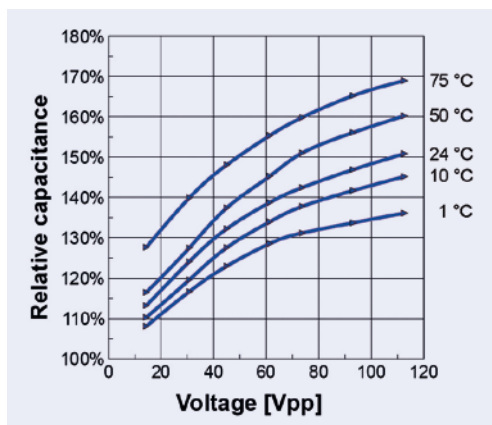

Fig. 40: Relative change of capacitance of a PICMA® Stack actuator measured at 1 kHz unipolar sine signal. The electrical capacitance increases along with the operating voltage and temperature

large-signal conditions, it is often sufficient to add a safety factor of 70% of the small-signal capacitance (fig. 40).

The small-signal capacitance C of a stack actuator can be estimated as for a capacitor:

$$C = n \epsilon_{33}^T \frac{A}{h_L} \quad (\text{Equation 21})$$

With a fixed actuator length l the following holds true with $n \approx l/h_L$:

$$C = l \epsilon_{33}^T \frac{A}{h_L^2} \quad (\text{Equation 22})$$

Accordingly, a PICMA® stack actuator with a layer thickness of 60 μm has an approx. 70 times higher capacitance than a PICA stack actuator with the same volume and a layer thickness of 500 μm . The electric power consumption P of both types is roughly the same due to the relationship $P \sim CV^2$ since the operating voltage changes proportionally to the layer thickness.

Positioning Operation, Static and with Low Dynamics

When electrically charged, the amount of energy stored in a piezo actuator is around $E = \frac{1}{2} CV^2$. Every change in the charge (and therefore in displacement) is connected with a charge transport that requires the following current I :

$$I = \frac{dQ}{dt} = C \cdot \frac{dV}{dt} \quad (\text{Equation 23})$$

Slow position changes only require a low current. To hold the position, it is only necessary to compensate for the very low leakage currents, even in the case of very high loads. The power consumption is correspondingly low.

Even when suddenly disconnected from the electrical source, the charged actuator will not make a sudden move. The discharge and thus the return to zero position will happen continuously and very slowly.

C	Capacitance [F]
n	Number of ceramic layers in the actuator
ϵ_{33}^T	Permittivity = ϵ_{33}/ϵ_0 (cf. table p. 40) [As/Vm]
A	Actuator cross-sectional area [m^2]
l	Actuator length [m]
h_L	Layer thickness in the actuator [m]
I	Current [A]
Q	Charge [C, As]
V	Voltage on the piezo actuator [V]
t	Time [s]

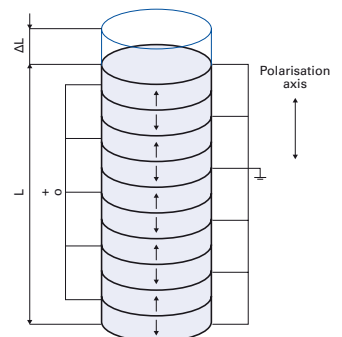

Fig. 41: Structure and contacting of a stacked piezo translator

The average current, peak current and small-signal bandwidth for each piezo amplifier from PI can be found in the technical data.

P	Power that is converted into heat [W]
$\tan \delta$	Dielectric loss factor (ratio of active power to reactive power)
f	Operating frequency [Hz]
C	Actuator capacitance [F]
V_{pp}	Driving voltage (peak-to-peak) [V]

Operation with Position Control

In closed-loop operation, the maximum safe operating frequency is also limited by the phase and amplitude response of the system. Rule of thumb: The higher the resonant frequency of the mechanical system, the higher the control bandwidth can be set. The sensor bandwidth and performance of the servo (digital or analog, filter and controller type, bandwidth) also limit the operating bandwidth of the positioning system.

Power Consumption of the Piezo Actuator

In dynamic applications, the power consumption of the actuator increases linearly with the frequency and actuator capacitance. A compact piezo translator with a load capacity of approx. 100 N requires less than 10 Watt of reactive power with 1000 Hz and 10 μm stroke, whereas a high-load actuator (>10 kN load) requires several 100 Watt under the same conditions.

Heat Generation in a Piezo Element in Dynamic Operation

Since piezo actuators behave like capacitive loads, their charge and discharge currents increase with the operating frequency. The thermal active power P generated in the actuator can be estimated as follows:

$$P \approx \frac{\pi}{4} \cdot \tan \delta \cdot f \cdot C \cdot V_{pp}^2 \quad (\text{Equation 24})$$

For actuator piezo ceramics under small-signal conditions, the loss factor is on the order of 0.01 to 0.02. This means that up to 2% of the electrical power flowing through the actuator is converted into heat. In the case of large-signal conditions, this can increase to considerably higher values (fig. 42). Therefore, the maximum operating frequency also depends on the permissible operating temperature. At high frequencies and voltage amplitudes,

Fig. 42: Dielectric loss factors $\tan \delta$ for different materials and control modes at room temperature and with quasistatic control. The conversion between voltage and field strength for specific actuators is done with the layer thicknesses that are given starting on p. 46. The actual loss factor in the component depends on further factors such as the mechanical preload, the temperature, the control frequency, and the amount of passive material.

cooling measures may be necessary. For these applications, PI Ceramic also offers piezo actuators with integrated temperature sensors to monitor the ceramic temperature.

Continuous Dynamic Operation

To be able to operate a piezo actuator at the desired dynamics, the piezo amplifier must meet certain minimal requirements. To assess these requirements, the relationship between amplifier output current, operating voltage of the piezo actuator, and operating frequency has to be considered.

Driving with Sine Functions

The effective or average current I_a of the amplifier specified in the data sheets is the crucial parameter for continuous operation with a sine wave. Under the defined ambient conditions, the average current values are guaranteed without a time limit.

$$I_a \approx f \cdot C \cdot V_{pp} \quad (\text{Equation 25})$$

Equation 26 can be used for sinusoidal single pulses that are delivered for a short time only. The equation yields the required peak current for a half-wave. The amplifier must be capable of delivering this peak current at least for half of a period. For repeated single pulses, the time average of the peak currents must not exceed the permitted average current.

$$I_{max} \approx f \cdot \pi \cdot C \cdot V_{pp} \quad (\text{Equation 26})$$

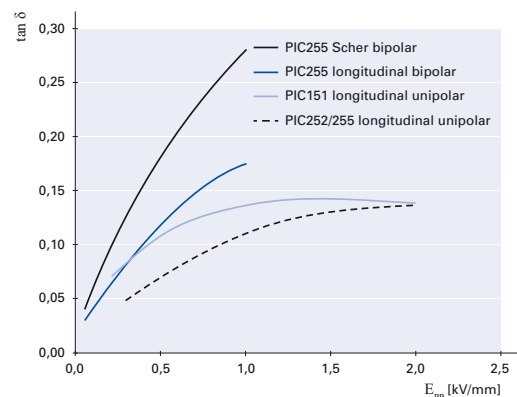

Driving with Triangular Waveform

Both the average current and the peak current of the amplifier are relevant for driving a piezo actuator with a symmetrical triangular waveform. The maximum operating frequency of an amplifier can be estimated as follows:

$$f_{max} \approx \frac{I}{C} \cdot \frac{I_a}{V_{pp}} \quad (\text{Equation 27})$$

A secondary constraint that applies here is that the amplifier must be capable of delivering at least $I_{max} = 2 I_a$ for the charging time, i.e. for half of the period. If this is not feasible, an appropriately lower maximum operating frequency should be selected. For amplifiers which cannot deliver a higher peak current or not for a sufficient period of time, the following equation should be used for calculation instead:

$$f_{max} \approx \frac{I}{2 \cdot C} \cdot \frac{I_a}{V_{pp}} \quad (\text{Equation 28})$$

Signal Shape and Bandwidth

In addition to estimating the power of the piezo amplifier, assessing the small-signal bandwidth is important with all signal shapes that deviate from the sinusoidal shape.

The less the harmonics of the control signal are transferred, the more the resulting shape returns to the shape of the dominant wave, i.e. the sinusoidal shape. The bandwidth should therefore be at least ten-fold higher than the basic frequency in order to prevent signal bias resulting from the nontransferred harmonics.

In practice, the limit of usable frequency portions to which the mechanical piezo system can respond is the mechanical resonant frequency. For this reason, the electrical control signal does not need to include clearly higher frequency portions.

Switching Applications, Pulse-Mode Operation

The fastest displacement of a piezo actuator can occur in 1/3 of the period of its resonant frequency (p. 58). Response times in the microsecond range and accelerations of more than 10000 g are feasible, but require particularly high peak current from the piezo amplifier.

This makes fast switching applications such as injection valves, hydraulic valves, switching relays, optical switches, and adaptive optics possible.

For charging processes with constant current, the minimal rise time in pulse-mode operation can be determined using the following equation:

$$t \approx C \cdot \frac{V_{pp}}{I_{max}} \quad (\text{Equation 29})$$

As before, the small-signal bandwidth of the amplifier is crucial. The rise time of the amplifier must be clearly shorter than the piezo response time in order not to have the amplifier limit the displacement. In practice, as a rule-of-thumb, the bandwidth of the amplifier should be two- to three-fold larger than the resonant frequency.

Advantages and Disadvantages of Position Control

A closed-loop controller always operates in the linear range of voltages and currents. Since the peak current is limited in time and is therefore nonlinear, it cannot be used for a stable selection of control parameters. As a result, position control limits the bandwidth and does not allow for pulse-mode operation as described.

In switching applications, it may not be possible to attain the necessary positional stability and linearity with position control. Linearization can be attained e.g. by means of charge-controlled amplifiers (p. 67) or by numerical correction methods.

I_a	Average current of the amplifier (source / sink) [A]
I_{max}	Peak current of the amplifier (source / sink) [A]
f	Operating frequency [Hz]
f_{max}	Maximum operating frequency [Hz]
C	Actuator capacitance, large signal [Farad (As/V)]
V_{pp}	Driving voltage (peak-to-peak) [V]
t	Time to charge piezo actuator to V_{pp} [s]

The small-signal bandwidth, average current and peak current for each piezo amplifier from PI can be found in the technical data.



Fig. 43: PICMA® actuators with patented, meander-shaped external electrodes for up to 20 A charging current

Ambient Conditions

PROPERTIES OF PIEZOELECTRIC ACTUATORS

In case of questions regarding use in special environments, please contact

info@pi.ws or
info@piceramic.com

Piezo actuators are suitable for operation in very different, sometimes extreme ambient conditions. Information on use at high temperatures of up to 200°C as well as in cryogenic environments is found starting on p. 52.

Vacuum Environment

Dielectric Stability

According to Paschen's Law, the breakdown voltage of a gas depends on the product of the pressure p and the electrode gap s . Air has very good insulation values at atmospheric pressure and at very low pressures. The minimum breakdown voltage of 300 V corresponds to a ps product of 1000 Pa mm. PICMA® Stack actuators with nominal voltages of considerably less than 300 V can therefore be operated at any intermediate pressure. In order to prevent breakdowns, PICA piezo actuators with nominal voltages of more than 300 V, however, should not be operated or only be driven at strongly reduced voltages when air is in the pressure range of 100 to 50000 Pa.

Outgassing

The outgassing behavior depends on the design and construction of the piezo actuators. PICMA® actuators are excellently suited to use in ultrahigh vacuums, since they are manufactured without polymer components and can be baked out at up to 150°C. UHV options with minimum outgassing rates are also offered for different PICA actuators.

Inert Gases

Piezo actuators are suitable for use in inert gases such as helium, argon, or neon. However, the pressure-dependent flashover resistances of the Paschen curves must also be observed here as well. The ceramic-insulated PICMA® actuators are recommended for this use, since their nominal voltage is below the minimum breakdown voltages of all inert gases. For PICA actuators with higher nominal voltages, the operating voltage should be decreased in particular pressure ranges to reduce the flashover risk.

Magnetic Fields

Piezo actuators are excellently suited to be used in very high magnetic fields, e.g. at cryogenic temperatures as well. PICMA® actuators are manufactured completely without ferromagnetic materials. PICA stack actuators are optionally available without ferromagnetic components. Residual magnetisms in the range of a few nanotesla have been measured for these products.

Gamma Radiation

PICMA® actuators can also be operated in high-energy, short-wave radiation, which occurs, for example, with electron accelerators. In long-term tests, problem-free use with total doses of 2 megagray has been proven.

Environments with High Humidity

When piezo actuators are operated in dry environments, their lifetime is always higher than in high humidity. When the actuators are operated with high-frequency alternating voltages, they self-heat, thus keeping the local moisture very low.

Continuous operation at high DC voltages in a damp environment can damage piezo actuators (p. 63). This especially holds true for the actuators of the PICA series, since their active electrodes are only protected by a polymer coating that can be penetrated by humidity. The actuators of the PICMA® series have an all-ceramic insulation, which considerably improves their lifetime in damp ambient conditions compared to polymer-coated actuators (p. 63).

Liquids

Encapsulated PICMA® or specially encased PICA actuators are available for use in liquids. For all other actuator types, direct contact with liquids should be avoided. Highly insulating liquids can be exceptions to this rule. Normally, however, the compatibility of the actuators with these liquids must be checked in lifetime tests.

Reliability of PICMA[®] Multilayer Actuators

PROPERTIES OF PIEZOELECTRIC ACTUATORS

Lifetime when Exposed to DC Voltage

In nanopositioning applications, constant voltages are usually applied to the piezo actuator for extended periods of time. In the DC operating mode, the lifetime is influenced mainly by atmospheric humidity.

If the humidity and voltage values are very high, chemical reactions can occur and release hydrogen molecules which then destroy the ceramic composite by embrittling it.

All-Ceramic Protective Layer

The patented PICMA[®] design suppresses these reactions effectively. In contrast to coating made just of polymer, the inorganic ceramic protective layer (p. 46) prevents the internal electrodes from being exposed to water molecules and thus increases the lifetime by several orders of magnitude (fig. 44).

Quasi-static Conditions: Accelerated Lifetime Test

Due to their high reliability, it is virtually impossible to experimentally determine the lifetime of PICMA[®] actuators under real application conditions. Therefore, tests under extreme load conditions are used to estimate the lifetime: Elevated atmospheric humidity and simultaneously high ambient temperatures and control voltages.

Fig. 44 shows the results of a test that was conducted at a much increased atmospheric humidity of 90% RH at 100 V DC and 22°C. The extrapolated mean lifetime (MTTF, mean time to failure) of PICMA[®] actuators amounts to more than 400000 h (approx. 47 years) while comparative actuators with polymer coating have an MTTF of only approx. one month under these conditions.

Tests under near-realistic conditions confirm or even surpass these results.

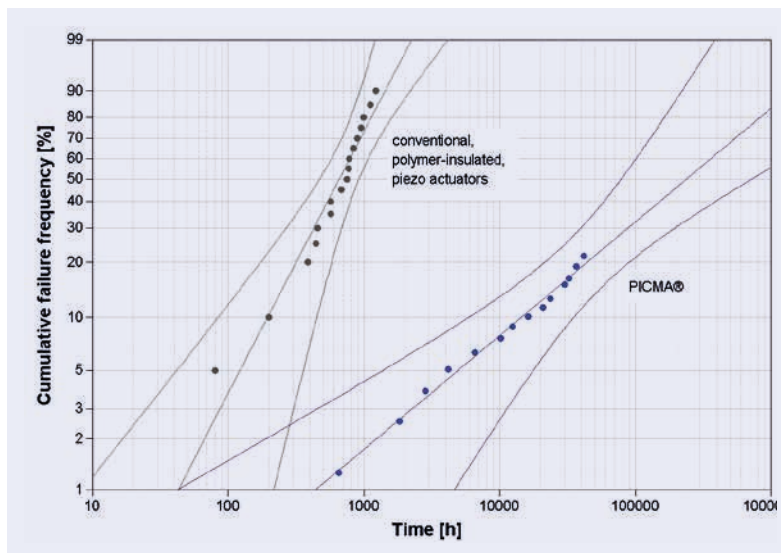

Fig. 44: Results of an accelerated lifetime test with increased humidity (test conditions: PICMA[®] Stack and polymer-coated actuators, dimensions: 5 x 5 x 18 mm³, 100 V DC, 22 °C, 90% RH)

Calculation of the Lifetime when Exposed to DC Voltage

Elaborate investigations have been done to develop a model for calculation of the lifetime of PICMA[®] Stack actuators. The following factors need to be taken into account under actual application conditions: Ambient temperature, relative atmospheric humidity, and applied voltage.

The simple formula

$$MTTF = A_U \cdot A_T \cdot A_F \quad (\text{Equation 30})$$

allows the quick estimation of the average lifetime in hours. The factors A_U as a function of the operating voltage, A_T for the ambient temperature and A_F for the relative atmospheric humidity can be read from the diagram (fig. 45).

Important:

Decreasing voltage values are associated with exponential increases of the lifetime. The expected lifetime at 80 V DC, for example, is 10 times higher than at 100 V DC.

This calculation can also be used to optimize a new application with regard to lifetime as early as in the design phase. A decrease in the driving voltage or control of temperature and atmospheric humidity by protective air or encapsulation of the actuator can be very important in this regard.

Fig. 45: Diagram for calculating the lifetime of PICMA® stack actuators when exposed to DC voltage. For continuous operation at 100 V DC and 75% atmospheric humidity (RH) and an ambient temperature of 45°C, the following values can be read from the diagram: $A_r=14$ (humidity, blue curve), $A_t=100$ (temperature, red curve), and $A_U=75$ (operating voltage, black curve). The product results in a mean lifetime of 105 000 h, more than 11 years

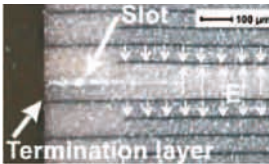
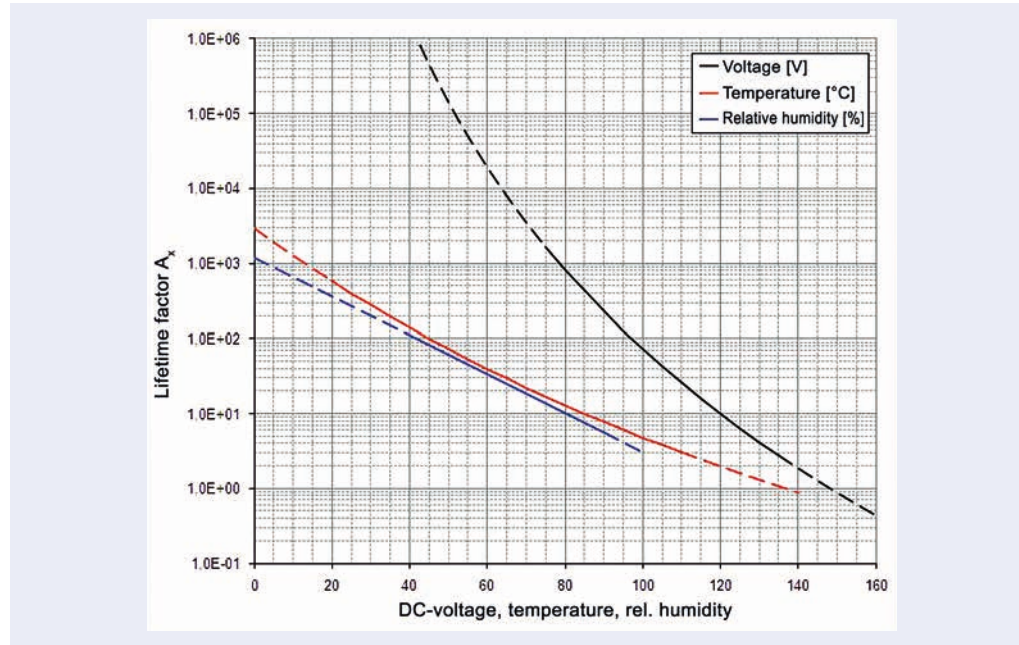

Fig. 46: The patented PICMA® actuator design with its defined slots preventing uncontrolled cracking due to stretching upon dynamic control is clearly visible

Lifetime in Dynamic Continuous Operation

Cyclic loads with a rapidly alternating electrical field and high control voltages (typically >50 Hz; >50 V) are common conditions for applications such as valves or pumps. Piezo actuators can reach extremely high cycles-to-failure under these conditions.

The most important factors affecting the lifetime of piezo actuators in this context are the electrical voltage and the shape of the signal. The impact of the humidity, on the other hand, is negligible because it is reduced locally by the warming-up of the piezo ceramic.

Ready for Industrial Application: 10¹⁰ Operating Cycles

Tests with very high control frequencies demonstrate the robustness of PICMA® piezo actuators. Preloaded PICMA® actuators with dimensions of 5 × 5 × 36 mm³ were loaded at room temperature and compressed air cooling with a sinusoidal signal of 120 V unipolar voltage at 1157 Hz, which corresponds to 10⁸ cycles daily. Even after more than 10¹⁰ cycles, there was not a single failure and the actuators showed no significant changes in displace-

ment. In recent performance and lifetime tests carried out by NASA, PICMA® actuators still produced 96% of their original performance after 100 billion (10¹¹) cycles. Therefore, they were chosen among a number of different piezo actuators for the science lab in the Mars rover "Curiosity". (Source: Piezoelectric multi-layer actuator life test. IEEE Trans Ultrason Ferroelectr Freq Control. 2011 Apr; Sherrit et al. Jet Propulsion Laboratory, California Institute of Technology, Pasadena, CA, USA)

Patented Design Reduces the Mechanical Stress

PICMA® actuators utilize a special patented design. Slots on the sides effectively prevent excessive increases of mechanical tensile stresses in the passive regions of the stack and the formation of un-controlled cracks (fig. 46) that may lead to electrical breakdowns and thus damage to the actuator. Furthermore, the patented meander-shaped design of the external contact strips (fig. 43) ensures all internal electrodes have a stable electrical contact even at extreme dynamic loads.

Piezo Electronics for Operating Piezo Actuators

CHARACTERISTIC BEHAVIOR OF PIEZO AMPLIFIERS

Fast step-and-settle or slow velocity with high constancy, high positional stability and resolution as well as high dynamics – the requirements placed on piezo systems vary greatly and need drivers and controllers with a high degree of flexibility.

The control electronics play a key role in the performance of piezoelectric actuators and nanopositioning systems. Ultra-low-noise, high-stability linear amplifiers are essential for precise positioning, because piezo actuators respond to the smallest changes in the control voltage with a displacement. Noise or drifting must be avoided as much as possible. The prerequisite for the high-dynamics displacement of the actuator is for the voltage source to provide sufficient current to charge the capacitance.

Power Requirements for Piezo Operation

The operating limit of an amplifier with a given piezo actuator depends on the amplifier power, the amplifier design and the capacitance of the piezo ceramics (cf. p. 60 – 61). In high-dynamics applications, piezo actuators require high charge and discharge currents. The peak current is of special importance, particularly for sinusoidal operation or pulse operation. Piezo amplifiers from PI are therefore designed so that they can output and sink high peak currents. If an amplifier is operated with a capacitive load and frequency at which it can no longer produce the required current, the output signal will be distorted. As a result, the full displacement can no longer be attained.

Amplifier Frequency Response Curve

The operating limits of each amplifier model are measured with different piezo loads depending on the frequency and output voltage and are graphically displayed as amplifier response curves to make the selection easier. The measurements are performed after 15 minutes of continuous operation (piezo and amplifier) at room temperature. In cold condition after power up, more power can be briefly available.

The power amplifier operates linearly within its operating limits so that the control signal is amplified without distortion. In particular, no thermal limitation takes place, i.e. the

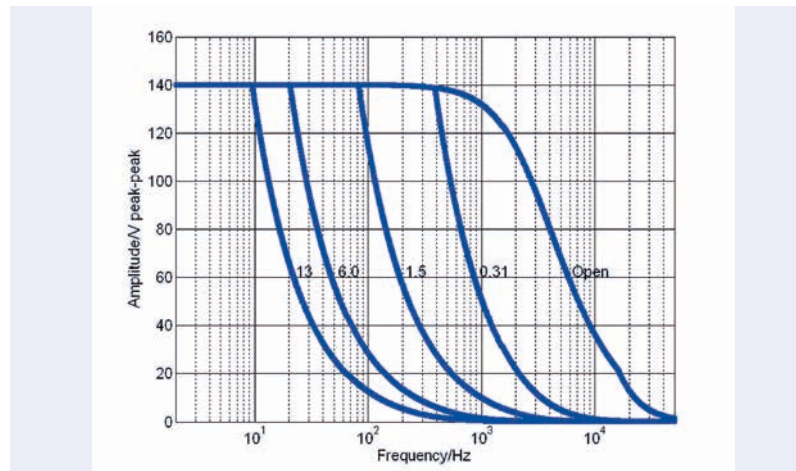

amplifier does not overheat, which could cause distortions of the sine wave. The amplifier continuously provides the output voltage even over a long time. This amplifier response curve cannot be used for peak values that are only available for a short period.

The curves refer to open-loop operation; in closed-loop operation, other factors limit the dynamics.

Setting the Operating Voltage

After the operating limit of the amplifier has been reached, the amplitude of the control voltage must be reduced by the same proportion as the output voltage falls, if the frequencies continue to increase. This is important because the current requirement continuously increases along with the frequency. Otherwise, the output signal will be distorted.

Example: The E-503 (E-663) amplifier can drive a 23 μF piezo capacitance with a voltage swing of 100 V and a maximum frequency of approximately 15 Hz (with sine wave excitation). At higher frequencies the operating limit decreases, e.g. to 80 V at 20 Hz. In order to obtain a distortion-free output signal at this frequency, the control input voltage must be reduced to 8 V (voltage gain = 10).

Fig. 47: Amplifier frequency response curve, determined with different piezo loads, capacitance values in μF. Control signal sine, operation period >15 min, 20°C

Solutions for High-Dynamics Operation

PIEZO ELECTRONICS FOR OPERATING PIEZO ACTUATORS

Switching Amplifiers with Energy Recovery

Piezo actuators are often used for an especially precise materials processing, for example in mechanical engineering for fine positioning in milling and turning machines. These require high forces as well as dynamics. The piezo actuators are correspondingly dimensioned for high forces; i.e. piezo actuators with a high capacity are used here. Particularly high currents are required to charge and discharge them with the necessary dynamics. The control of valves also requires similar properties.

a piezo is discharged and makes the energy available again for the next charging operation. This permits energy savings of up to 80% to be realized. Furthermore, the amplifier does not heat up as much and thus influences the actual application less.

Unlike conventional class D switching amplifiers, PI switching amplifiers for piezo elements are current- and voltage-controlled. Product examples are the E-617 for PICMA[®] actuators and E-481 for the PICA actuator series.

Energy Recovery Minimizes the Energy Consumption in Continuous Operation

Since these applications frequently run around the clock, seven days a week, the energy consumption of the amplifier is particularly important. For this purpose, PI offers switching amplifier electronics with which the pulse width of the control signal is modulated (PWM) and the piezo voltage is thereby controlled. This results in an especially high efficiency. In addition, a patented circuitry for energy recovery is integrated: this stores part of the returning energy in a capacitive store when

Protection of the Piezo Actuator through Overtemperature Protection

In continuous operation, the heat development in the piezo actuator is not negligible (p. 60). Corresponding electronics can therefore evaluate the signals of a temperature sensor on the piezo. This protects the ceramic from overheating and depolarization.

Valid patents

German patent no. 19825210C2
International patent no. 1080502B1
US patent no. 6617754B1



Fig. 48: Piezo actuator in a case with connections for temperature sensor and cooling air

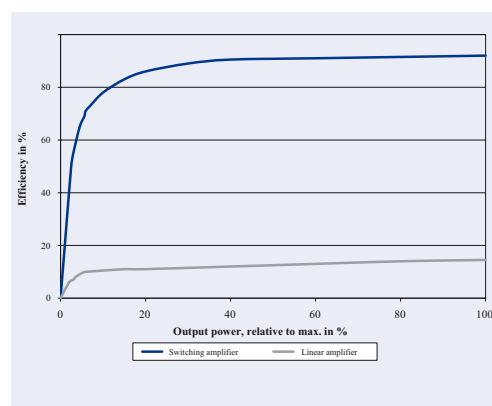

Fig. 49: Thanks to their patented energy recovery system, PI amplifiers only consume approx. 20% of the power required by a corresponding linear amplifier with the same output power

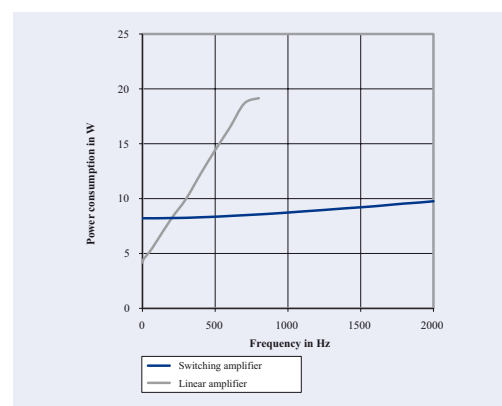

Fig. 50: Power consumption of a piezo amplifier with linear and switched-mode amplifier at the piezo output, capacitive load 1 μ F. The measured values clearly show that the pulse width modulated amplifier allows significantly higher dynamics than the classic linear amplifier. The linear amplifier reaches the upper limit of its power consumption at frequencies of up to approx. 700 Hz, the switching amplifier does not reach the limit until far beyond 2 kHz

Linearized Amplifiers for Piezo Displacement Without Hysteresis

PIEZO ELECTRONICS FOR OPERATING PIEZO ACTUATORS

Charge Control

A typical application for piezo actuators or nanopositioning systems is dynamic scanning. This involves two different methods: step-and-settle operation with precise and repeatable position control on the one hand, and ramp operation with especially linear piezo displacement on the other. The first method requires a closed servo loop which ensures that positions can be approached precisely and repeatedly with constant step sizes.

Of course, ramp operation with linear piezo displacement is also possible using position feedback sensors and a servo loop. However, in this case, the servo loop will determine the dynamics of the entire system which sometimes significantly limits the number of cycles per time unit. This can be avoided by means of an alternative method of amplification: charge control.

Charge and Displacement

Charge control is based on the principle that the displacement of piezo actuators is much more linear when an electrical charge is applied instead of a voltage. The hysteresis is only 2% with electrical charges, whereas it is between 10 and 15% with open-loop control voltages (fig. 51). Therefore, charge control can often be used to reach the required precision even without servo loop. This enhances the dynamics and reduces the costs. Charge control is not only of advantage as regards highly dynamic applications but also when it comes to operation at very low frequencies. However, charge control is not suitable for applications where positions need to be maintained for a longer period of time.

For dynamic applications:

- Active vibration damping
- Adaptronics
- High-speed mechanical switches
- Valve control (e.g. pneumatics)
- Dispensing



The charge-controlled E-506.10 power amplifier offers highly linear, dynamic control for PICMA® piezo actuators

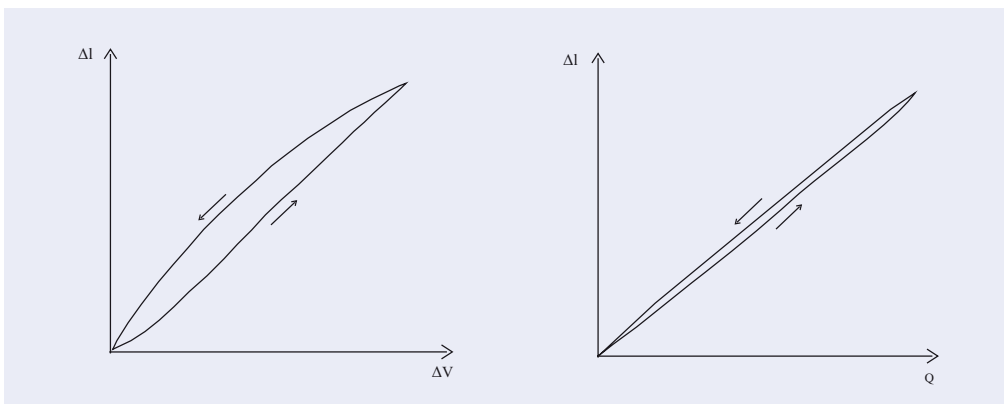

Fig. 51: Typical expansion of piezo actuators in relation to the applied voltage (left) and the charge (right). Controlling the applied charge significantly reduces the hysteresis

Handling of Piezo Actuators

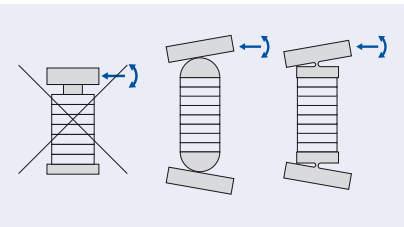

Fig. 52: Avoiding lateral forces and torques

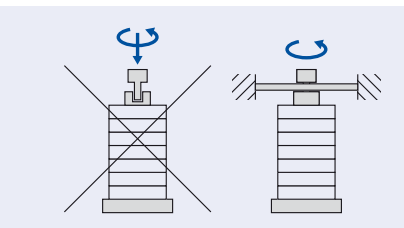

Fig. 53: Prevention of torques

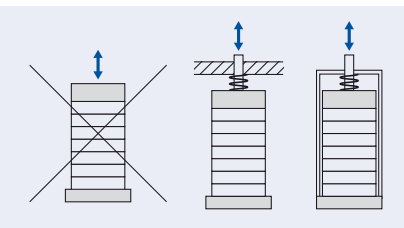

Fig. 54: Avoiding tensile stresses by means of a mechanical preload

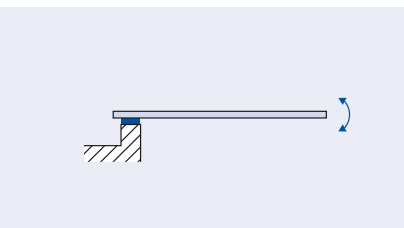

Fig. 55: Mounting of a one-sidedly clamped bending actuator by gluing

Piezo actuators are subject to high mechanical and electrical loads. Moreover, the brittle ceramic or crystalline materials require careful handling.

- ▶ Avoid mechanical shocks to the actuator, which can occur if you drop the actuator, for example.
- ▶ Do not use metal tools during installation.
- ▶ Avoid scratching the ceramic or polymer coating and the end surfaces during installation and use.
- ▶ Prevent the ceramic or polymer insulation from coming into contact with conductive liquids (such as sweat) or metal dust.
- ▶ If the actuator is operated in a vacuum: Observe the information on the permissible piezo voltages for specific pressure ranges (p. 62).
- ▶ If the actuator could come into contact with insulating liquids such as silicone or hydraulic oils: Contact info@piceramic.com.
- ▶ If the actuator has accidentally become dirty, carefully clean the actuator with isopropanol or ethanol. Next, completely dry it in a drying cabinet. Never use acetone for cleaning. When cleaning in an ultrasonic bath, reduce the energy input to the necessary minimum.
- ▶ Recommendation: Wear gloves and protective glasses during installation and start-up.

DuraAct patch actuators and encapsulated PICMA[®] piezo actuators have a particularly robust construction. They are partially exempt from this general handling information.

Mechanical Installation (fig. 52, 53, 54)

- ▶ Avoid torques and lateral forces when mounting and operating the actuator by using suitable structures or guides.
- ▶ When the actuator is operated dynamically: Install the actuator so that the center of mass of the moving system coincides with the actuator axis, and use a guiding for very large masses.
- ▶ Establish contact over as large an area as possible on the end surfaces of a stack actuator.
- ▶ Select opposing surfaces with an evenness of only a few micrometers.

Gluing

- ▶ If the mounting surface is not even, use epoxy resin glue for gluing the actuators. Cold-hardening, two-component adhesives are well suited for reducing thermo-mechanical stresses.
- ▶ Maintain the operating temperature range specified for the actuator during hardening and observe the temperature expansion coefficients of the involved materials.

Uneven mounting surfaces are found, for example, with PICMA[®] Bender and PICMA[®] Chip actuators, since these surfaces are not ground after sintering (fig. 55).

Applying a Preload (fig. 54)

- ▶ Create the preload either externally in the mechanical structure or internally in a case.
- ▶ Apply the preload near the axis within the core cross-section of the actuator.
- ▶ If the actuator is dynamically operated and the preload is created with a spring: Use a spring whose total stiffness is approximately one order of magnitude less than that of the actuator.

Introducing the Load Evenly (fig. 56)

The parallelism tolerances of the mechanical system and the actuator result in an irregular load distribution. Here, compressive stresses may cause tensile stresses in the actuator. Regarding the even application of a load, there are diverse design solutions that differ from each other in axial stiffness, separability of the connection and rotatability in operation, e.g. in the case of lever amplification.

- Gluing the actuator (cf. gluing section)
- Hardened spherical end piece with point contact to even opposing surface
- Hardened spherical end piece with ring contact to a spherical cap
- Connection via a flexure joint
- ▶ If the actuator is coupled in a milling pocket, make sure that there is full-area contact on the end surface of the actuator. For this purpose, select the dimensions of the milling pocket correspondingly or make free cuts in the milling pocket (fig. 57).
- ▶ If a point load is applied to the end piece of the actuator: Dimension the end piece so that its thickness corresponds to half the cross-sectional dimension in order to prevent tensile stresses on the actuator (fig. 58).

Electrical Connection (fig. 59)

From an electrical point of view, piezo actuators are capacitors that can store a great amount of energy. Their high internal resistances lead to very slow discharges with time constants in the range of hours. Mechanical or thermal loads electrically charge the actuator.

- ▶ Connect the case or the surrounding mechanics to a protective earth conductor in accordance with the standards.

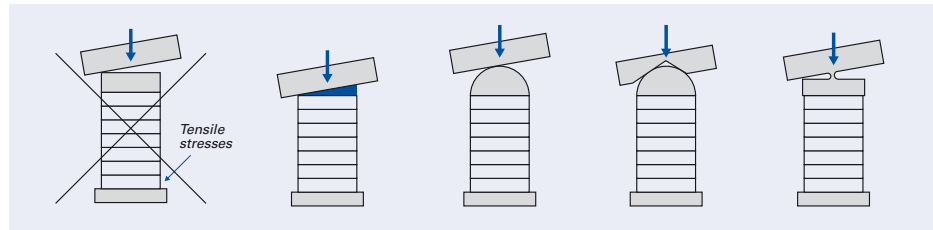

Fig. 56: Avoiding an irregular load application

- Electrically insulate the actuator against the peripheral mechanics. At the same time, observe the legal regulations for the respective application.
- Observe the polarity of the actuator for connection.
- Only mount the actuator when it is short-circuited.
- When the actuator is charged: Discharge the actuator in a controlled manner with a 10 kΩ resistance. Avoid directly short-circuiting the terminals of the actuator.
- ▶ Do not pull out the connecting cable of the amplifier when voltage is present. The mechanical impulse triggered by this could damage the actuator.

Safe Operation

- ▶ Reduce the DC voltage as far as possible during actuator operation (p. 63). You can decrease offset voltages with semi-bipolar operation.
- ▶ Always power off the actuator when it is not needed.
- ▶ Avoid steep rising edges in the piezo voltage, since they can trigger strong dynamic forces when the actuator does not have a preload. Steep rising edges can occur, for example, when digital wave generators are switched on.

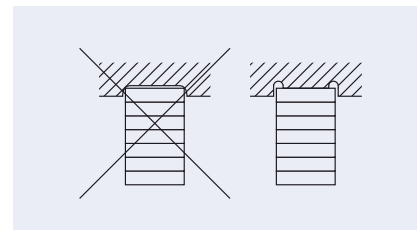

Fig. 57: Full-area contact of the actuator

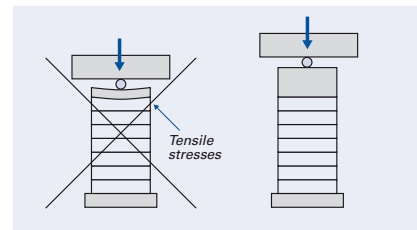

Fig. 58: Proper dimensioning of the end pieces in the case of point contact

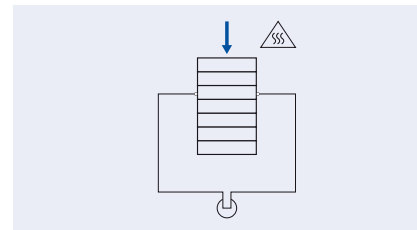
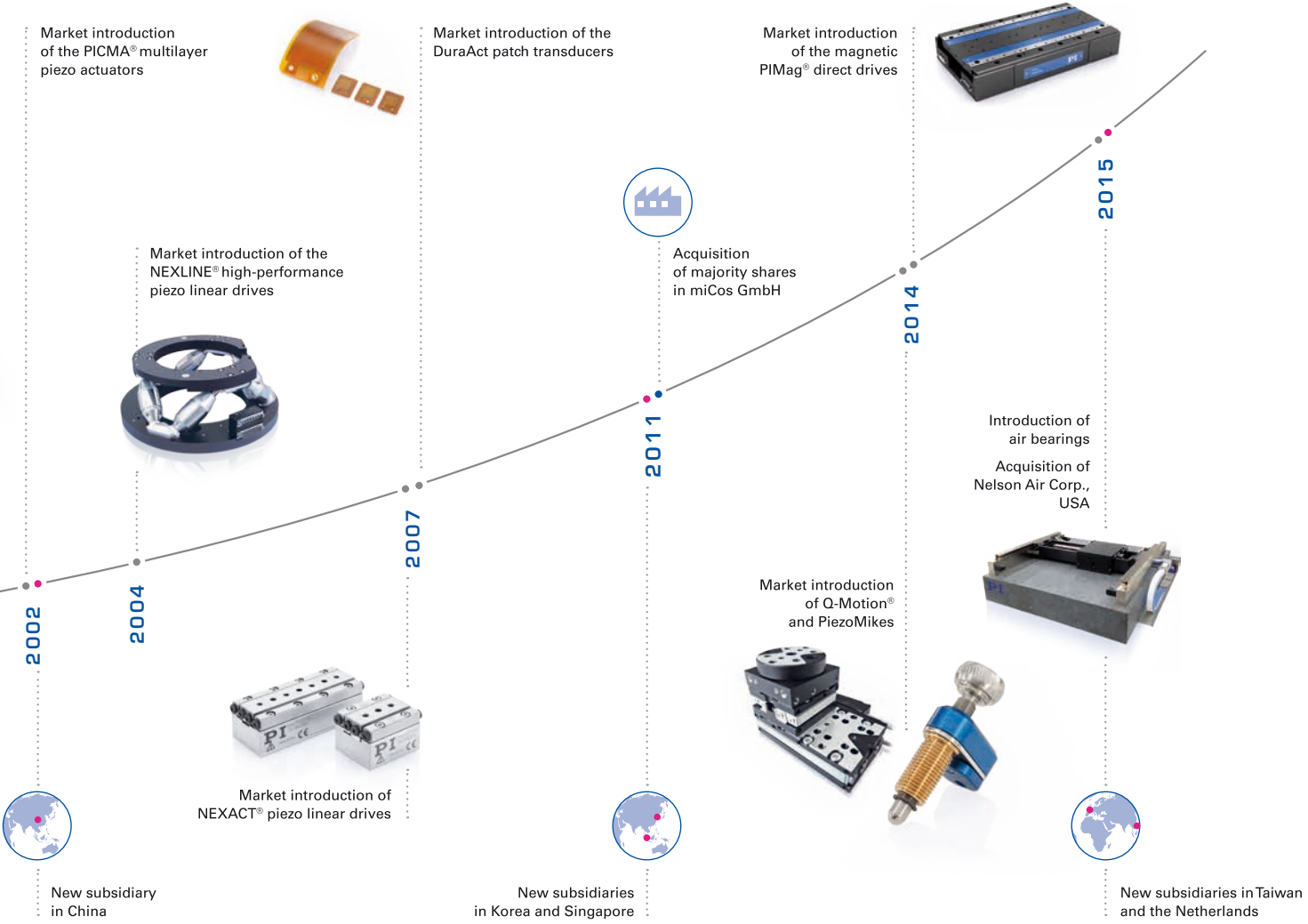

Fig. 59: Mechanical loads electrically charge the actuator. Mounting only when short-circuited

The PI Group Milestones

A SUCCESS STORY





Product Overview



PICMA® multilayer piezo actuators



Piezoelectric components

PIEZO ACTUATORS AND COMPONENTS, PRELOADED PIEZO ACTUATORS

Variable Designs, Optionally with Position Measurement, UHV Versions, High Dynamics, Sub-Millisecond Response Time, Picometer Resolution

PIEZO SCANNERS AND POSITIONING STAGES

Nanometer Precision and Millisecond Settling Time



Fast tip/tilt mirrors

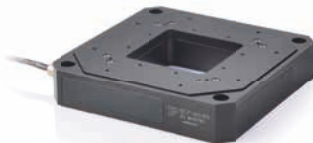

Technology for up to six axes: flexure joints, capacitive sensors, PICMA® piezo actuators



Piezo scanners and lens focusers: microscope lens and specimen fast and precise positioning

PRECISION LINEAR ACTUATORS AND DIRECT DRIVES



Linear actuator with piezomotor for high resolution and drift-free long-term positioning



Voice-coil drive for high dynamics, optional force sensor for force-control operation



High load actuators with axial forces up to 400 N for industrial automation

PRECISION LINEAR POSITIONING STAGES

From Miniature Positioning Stages to Travel Ranges of 1 m



Miniature stages with piezomotors

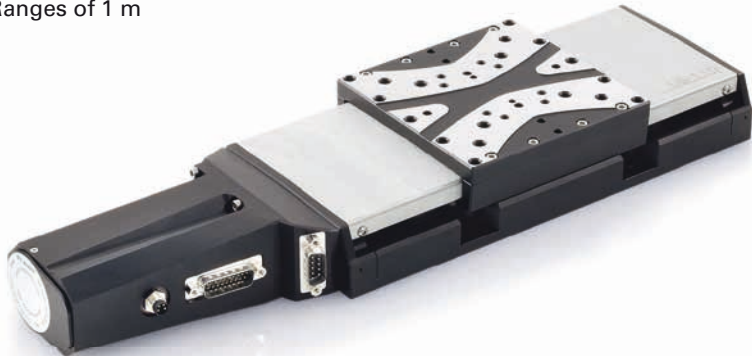

High-precision positioning stages



Ultraprecision with air bearings



High velocity and precision due to magnetic direct drives

HEXAPOD AND SPACEFAB

Parallel Kinematics for Precise Positioning in Six Axes



Compact design for microassembly

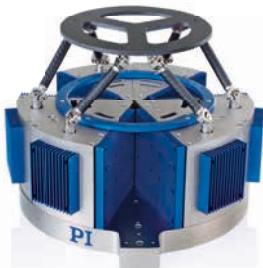

Dynamic hexapod for motion simulation



High-load Hexapods for 1000 kg loads



Headquarters

GERMANY

PI Ceramic GmbH

Lindenstrasse
Lederhose
Phone +49 36604 882-0
Fax +49 36604 882-4109
info@piceramic.com
www.piceramic.com

Physik Instrumente (PI) GmbH & Co. KG

Auf der Roemerstrasse 1
76228 Karlsruhe
Phone +49 721 4846-0
Fax +49 721 4846-1019
info@pi.ws
www.pi.ws

PI miCos GmbH

Freiburger Strasse 30
Eschbach
Phone +49 7634 5057-0
Fax +49 7634 5057-99
info@pimicos.com
www.pi.ws



Visit us on
youtube!



© Physik Instrumente (PI) GmbH & Co. KG

All contents, including texts, graphics, data etc., as well as their layout, are subject to copyright and other protective laws. Any copying, modification or redistribution in whole or in parts is subject to a written permission of PI.

Although the information in this document has been compiled with the greatest care, errors cannot be ruled out completely. Therefore, we cannot guarantee for the information being complete, correct and up to date. Illustrations may differ from the original and are not binding. PI reserves the right to supplement or change the information provided without prior notice.

Subsidiaries

USA (East) & CANADA

PI (Physik Instrumente) L.P.
Auburn, MA 01501
www.pi-usa.us

USA (San Francisco Bay Area Office)

PI (Physik Instrumente) L.P.
Sausalito, CA 94965
www.pi-usa.us

ITALY

Physik Instrumente (PI) S. r. l.
Bresso
www.pionline.it

FRANCE

PI France SAS
Aix-en-Provence
www.pi.ws

JAPAN

PI Japan Co., Ltd.
Tokyo
www.pi-japan.jp

CHINA

Physik Instrumente
(PI Shanghai) Co., Ltd.
Shanghai
www.pi-china.cn

SOUTHEAST ASIA

PI (Physik Instrumente)
Singapore LLP
Singapore
www.pi-singapore.sg
For ID / MY / PH / SG / TH / VNM

KOREA

PI Korea Ltd.
Seoul
www.pikorea.co.kr

USA (West) & MEXICO

PI (Physik Instrumente) L.P.
Irvine, CA 92620
www.pi-usa.us

UK & IRELAND

PI (Physik Instrumente) Ltd.
Cranfield, Bedford
www.physikinstrumente.co.uk

NETHERLANDS

PI Benelux B.V.
Sint-Oedenrode
www.pi.ws

SPAIN

Micos Iberia S.L.
Vilanova i la Geltrú
www.pimicos.es

PI Japan Co., Ltd.
Osaka
www.pi-japan.jp

Physik Instrumente
(PI Shanghai) Co., Ltd.
Peking
www.pi-china.cn

TAIWAN

Physik Instrumente (PI)
Taiwan Ltd.
Taipeh
www.pi-taiwan.com.tw